

**D-Series – Laser Distance Sensor**  
**DPE-10-500 | DPE-30-500**  
**DEN-10-500 | DEH-30-500**  
**DAN-10-150 | DAN-30-150 | DAE-10-050**  
**DBN-50-050**



**Technical Reference Manual**

V1.16

24.07.2025



# Table of content

- 1 Document scope ..... 3
- 2 Safety instructions ..... 3
  - 2.1 Explanation of symbols..... 3
  - 2.2 Permitted use..... 4
  - 2.3 Prohibited use/Limits to use..... 4
  - 2.4 Areas of responsibility..... 5
  - 2.5 Hazards in use..... 5
  - 2.6 Laser classification..... 6
  - 2.7 Laser specification..... 6
  - 2.8 Electromagnetic compatibility (EMC)..... 6
  - 2.9 Producer standards..... 6
  - 2.10 Disposal..... 7
  - 2.11 Labeling..... 7
  - 2.12 Maintenance..... 8
  - 2.13 Service..... 8
- 3 Introduction ..... 9
  - 3.1 Product identification..... 10
  - 3.2 Components..... 11
  - 3.3 Validity..... 11
- 4 Technical data ..... 12
  - 4.1 Specifications..... 12
  - 4.2 Physical dimensions..... 14
  - 4.3 Measuring accuracy definition..... 14
- 5 Electrical components ..... 15
  - 5.1 Power supply..... 15
  - 5.2 Reset push button..... 16
  - 5.3 Status LED..... 17
  - 5.4 Digital output..... 17
  - 5.5 Digital input..... 18
  - 5.6 Analog output..... 18
  - 5.7 RS-232 interface..... 20
  - 5.8 RS-422/485 interface..... 21
  - 5.9 SSI interface..... 23
  - 5.10 USB interface..... 24
  - 5.11 Industrial Ethernet interface..... 25
- 6 Configuration ..... 27
  - 6.1 Configuration process..... 27
  - 6.2 Operation modes..... 29
  - 6.3 Measuring characteristic..... 30
  - 6.4 Data output..... 32
  - 6.5 Digital output..... 34
  - 6.6 Factory settings..... 36
- 7 Operation ..... 37
  - 7.1 Measurement overview..... 37
  - 7.2 Installation..... 37
  - 7.3 Measuring performance influence..... 38
  - 7.4 Prevention of erroneous measurements..... 39
  - 7.5 Laser life time consideration..... 40
  - 7.6 Heating functionality..... 40
  - 7.7 Application Notes / Examples..... 40
- 8 Command set ..... 41
  - 8.1 General..... 41
  - 8.2 Operation commands..... 41
  - 8.3 Configuration commands..... 44
  - 8.4 Extended configuration commands..... 51
  - 8.5 Information commands..... 53
  - 8.6 Error codes..... 54
- 9 Frequently asked questions (FAQ's) ..... 56
- 10 Glossary ..... 56
- 11 Revision history ..... 56

## 1 Document scope

This document covers the Dimetix D-Series Laser Distance Sensors. The available sensor types are listed in chapter 3.1 Product identification. The following topics are discussed:

- Safety instructions
- Technical information

## 2 Safety instructions



- The following instructions are to enable the person responsible for the D-Series device, and the user of the instrument, to anticipate and avoid operational hazards.
- The D-Series device is made to be integrated into technical systems. Basic technical training is therefore essential. This device may only be operated by trained personnel.
- The person responsible for the instrument must ensure that all users understand these instructions and adhere to them.
- If the D-Series device is part of a system, the manufacturer of such a system is responsible for all safety-related issues, such as the manual, labeling and instruction.

### 2.1 Explanation of symbols



Indicates an imminently hazardous situation which, if not avoided, will result in death or serious injury.



Indicates a potentially hazardous situation which, if not avoided, could result in death or serious injury.



Indicates a potentially hazardous situation which, if not avoided, could result in minor or moderate injury.

**NOTICE**

Indicates a potentially harmful situation which, if not avoided, may lead to property damage.



Highlights important information, product features and application hints.



Means that the eye can be damaged by laser radiation, if precautions are not taken.



Means that the device can be damaged by electrostatic discharge, if precautions are not taken.



## 2.2 Permitted use

The permitted use of the D-Series device is: Measuring distances in an atmosphere appropriate for permanent human habitation.

## 2.3 Prohibited use/Limits to use

### Prohibited use or ignoring limits to use can lead to injury, malfunction, and material damage.

- It is the duty of the person responsible for the instrument to inform the user about hazards and how to counteract them.
- The D-Series devices must not be operated until the user has been adequately instructed.

### Prohibited use:

- Use of the instrument without instruction
- Use outside the stated limits
- Deactivation of safety systems and removal of explanatory and hazard labels
- Opening of the equipment, except to open the cover for access to the screw terminal
- Carrying out modification or conversion of the product
- Operation after failure in operation
- Use of accessories from other manufacturers without the express approval of Dimetix
- Aiming directly into the sun
- Deliberate dazzling of third parties; also in the dark
- Inadequate safeguards at the surveying location (e.g. when measuring on roads, etc.)



**NOTICE**

### Environmental limits to use.

The device must not be used in environments such as but not limited to:

- Aggressive vapor or liquids (salt, acid, poison, etc.)
- Snow and rain
- Radiation (radioactive, heat, etc.)
- Explosive atmosphere
- High-gloss measurement surfaces

### Limits to use by application.

The device must not be used in applications such as but not limited to.

- Aerospace (Aviation & Space flight)
- Nuclear technology

### Further limits to use.

See chapter 4 Technical data on page 12.



## 2.4 Areas of responsibility

### Responsibilities of the manufacturer of the original equipment Dimetix AG, CH-9100 Herisau (Dimetix):

Dimetix is responsible for supplying the product, including the Technical Reference Manual and original accessories, in a completely safe condition.

### Responsibilities of the manufacturer of non-Dimetix accessories:

The manufacturers of non-Dimetix accessories for the D-Series devices are responsible for developing, implementing and communicating safety concepts for their products. They are also responsible for the effectiveness of these safety concepts in combination with the Dimetix equipment.

### Responsibilities of the person in charge of the instrument:

The person in charge of the instrument has the following duties:

- To understand the safety instructions for the product and the instructions in the Technical Reference Manual.
- To be familiar with local safety regulations relating to accident prevention.
- To inform Dimetix immediately if the equipment becomes unsafe.



The person responsible for the instrument must ensure that the equipment is used in accordance with the instructions. This person is also accountable for the deployment of personnel and for their training and for the safety of the equipment when in use.

## 2.5 Hazards in use



**NOTICE**

**The absence of instruction, or the inadequate provision of instruction, can lead to incorrect or prohibited use, and can give rise to accidents with far-reaching personal, material and environmental consequences.**

- All users must follow the safety instructions given by the manufacturer and the directions of the person responsible for the instrument.



**NOTICE**

**Beware of erroneous distance measurements if the instrument is defective or if it has been dropped or has been misused or modified.**

- Carry out periodic test measurements, particularly after the instrument has been subject to abnormal use, and before, during and after important measurements.
- Make sure the D-Series device optics are kept clean.



**If labels are hidden when the D-Series device is installed, this could lead to dangerous situations.**

- Always ensure the visibility of D-Series device labels at all times or add labels in accordance with the local safety regulations.



**NOTICE**

**When using the instrument for distance measurements or for positioning moving objects (e.g. cranes, building equipment, platforms, etc.) unforeseen events (e.g. breaking the laser beam) may cause erroneous measurements.**

- Only use this product as a measuring sensor, not as a control device. The system must be configured and operated in such a way that no damage will occur in the event of an erroneous measurement, malfunction of the device or power failure due to installed safety measures (e.g. safety limit switch).



**NOTICE**

**Operate the equipment appropriately in accordance with the regulations in force.**

- Always prevent access to the equipment by unauthorized personnel.





**Be careful when pointing a telescope towards the sun, because the telescope functions as a magnifying glass and can injure eyes and/or cause damage inside the D-Series device.**



- Do not point the telescope directly at the sun.

## 2.6 Laser classification

The D-Series device produces a visible laser beam, which emerges from the front of the instrument.

It is a Class 2 laser product in accordance with:

- IEC 60825-1 Ed. 3 "Radiation safety of laser products"

It is a Class II laser product in accordance with:

- FDA 21 CFR 1040.10 / 1040.11 and Laser Notice 56 (US Department of Health and Human Service, Code of Federal Regulations)

### Laser Class 2/II products

Do not stare into the laser beam or direct it towards other people unnecessarily. Eye protection is normally afforded by aversion responses including the blink reflex.



**Looking directly into the beam with optical aids (binoculars, telescopes) can be hazardous.**



**Looking into the laser beam may be hazardous to the eyes.**

- Do not look into the laser beam. Make sure the laser is aimed above or below eye level. (particularly with fixed installations, in machines, etc.).



## 2.7 Laser specification

Standard applied	IEC 60825-1 Ed. 3
Emitted wavelength	620...690 nm (typical 655 nm)
Beam divergence	0.16 x 0.6 mrad
Pulse duration	0.2...0.8 x 10 <sup>-9</sup> s
Max. radiant power	1 mW
Laser power measurement uncertainty	±5%

## 2.8 Electromagnetic compatibility (EMC)

The term "electromagnetic compatibility" is taken to mean the capability of the D-Series devices to function smoothly in an environment where electromagnetic radiation and electrostatic discharges are present, and without causing electromagnetic interference to other equipment.

**Electromagnetic radiation can cause interference in other equipment.**



- Although the D-Series device meets the strict regulations and standards that are in force in this respect, Dimetix cannot completely exclude the possibility that interference may be caused to other equipment.

## 2.9 Producer standards

Dimetix hereby certifies that the product has been tested and complies with the specifications as stated in this 'Technical Reference Manual'. The test equipment used is in compliance with national and international standards. This is established by our Quality Management System. Further, the D-Series devices are produced in compliance with 2011/65/EU «RoHS».



## 2.10 Disposal



This symbol on the product or on its packaging indicates that this product must not be disposed of with your other household waste. Instead, it is your responsibility to dispose of the equipment by handing it over to a designated collection point for the recycling of waste electrical and electronic equipment. The separate collection and recycling of your waste equipment at the time of disposal will help to conserve natural resources and ensure that it is recycled in a manner that protects human health and the environment. For more information about where you can drop off your waste equipment for recycling, please contact your local city office, your household waste disposal service or the dealer where you purchased the product.

In countries in which Dimetix has no subsidiaries, Dimetix delegates the duty for the disposal in compliance with 2012/19/EU «WEEE» to the local dealer or to the customer, if no dealer is present.

## 2.11 Labeling

The labeling of the D-Series devices is shown in figure 1. The existing device type labels and the complete flat label with device type are shown in figure 2 and 3.

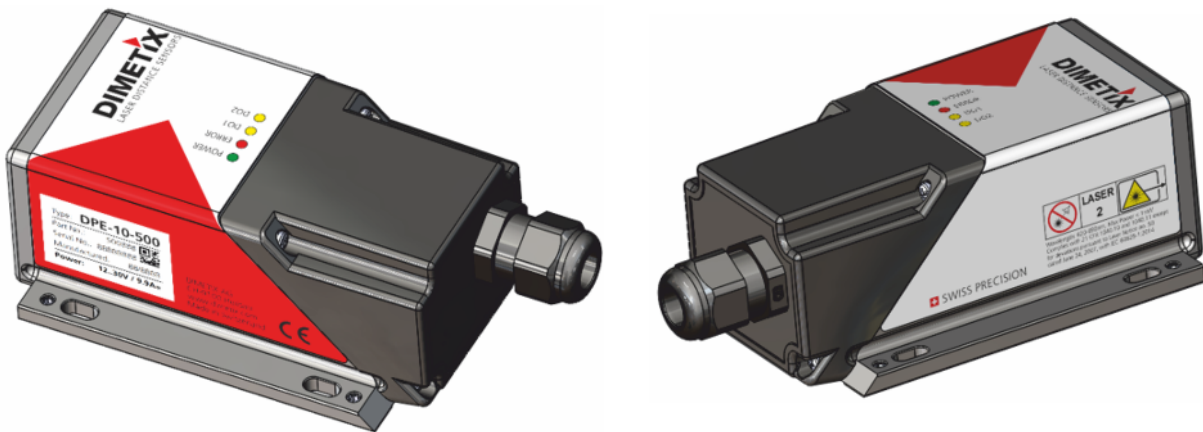

Figure 1: Labeling of the D-Series devices (Label position and view)

Type: <b>DPE-10-500</b> Part No.: 500630 Serial No.: 12345678 Manufactured: 05/2019 Power: 12..30V / 0.8A=	Type: <b>DPE-30-500</b> Part No.: 500636 Serial No.: 12345678 Manufactured: 05/2019 Power: 12..30V / 0.8A=
Type: <b>DEN-10-500</b> Part No.: 500637 Serial No.: 12345678 Manufactured: 05/2019 Power: 12..30V / 0.2A=	Type: <b>DEH-30-500</b> Part No.: 500638 Serial No.: 12345678 Manufactured: 05/2019 Power: 12..30V / 0.2A=
Type: <b>DAN-10-150</b> Part No.: 500632 Serial No.: 12345678 Manufactured: 05/2019 Power: 12..30V / 0.2A=	Type: <b>DAN-30-150</b> Part No.: 500634 Serial No.: 12345678 Manufactured: 05/2019 Power: 12..30V / 0.2A=
Type: <b>DAE-10-050</b> Part No.: 500633 Serial No.: 12345678 Manufactured: 05/2019 Power: 12..30V / 0.8A=	Type: <b>DBN-50-050</b> Part No.: 500635 Serial No.: 12345678 Manufactured: 05/2019 Power: 12..30V / 0.2A=

Figure 2: Existing D-Series device type labels

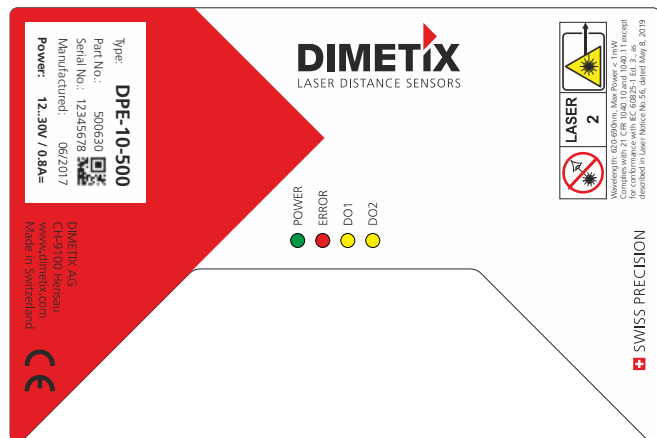

Figure 3: Complete D-Series label with device type



## 2.12 Maintenance

The D-Series device is almost maintenance free. The only thing you have to do is to clean the surfaces of the lenses.

### NOTICE

#### Dirty sensor optics can cause erroneous measurements.

- The sensor can be contaminated by dust, oil, ice, water etc.
- In dirty environments try to reduce contamination by design.
- Regularly check sensor optics and clean if necessary.

### NOTICE

#### Inadequate cleaning methods can damage the sensor optics.

- Look after the surfaces of the lenses with same care that you would apply to spectacles, cameras and field glasses.
- Clean the optical parts (small laser output glass and the round lens) only with a clean soft glasses cleaning cloth and avoid scratching of the optical parts. All other cleaner or solvent are not allowed.

## 2.13 Service

If you need to service the device, please contact Dimetix for instructions.



The warranty is void if the device is opened except the exchangeable cover of the screw terminal. Removing the label is also understood as opening.

### 3 Introduction

The D-Series sensors are powerful distance-measuring instruments for integration into industrial applications. They allow accurate and contactless distance measurement over a wide range using the laser beam reflection on a measuring surface / target (see the illustration in figure 4).

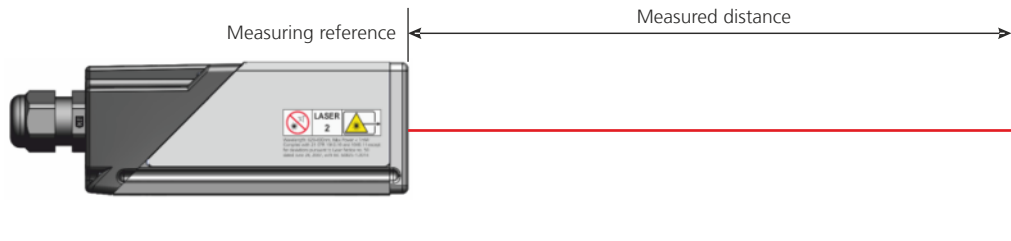

Figure 4: Standard application for measuring distances

#### Key features:

- Measurement range 0.05 up to 500 m
- Measuring accuracy up to  $\pm 1.0$  mm (@  $2\sigma$ )
- High measurement speed (up to 250 Hz, 1000 Hz output rate)
- Several serial interfaces (RS-232, RS-422 / RS-485, SSI and USB)
- Exchangeable cover for Industrial Ethernet (PROFINET®, EtherNet/IP™ or EtherCAT® interface as accessory)
- Connection of up to 100 sensors on a single RS-422 / RS-485 line
- Wide range of power supply (12...30 VDC)
- Programmable analog output (0/4...20 mA)
- One programmable digital input (DI1)
- Two programmable digital outputs (DO1 and DO2)
- Digital output for error signalization (DOE)
- Selectable digital output type (NPN, PNP, Push-Pull)
- 4 LED's for status signaling
- ASCII protocol to control external displays
- Screw terminal for easy connection of the D-Series sensors
- IP65 (protected against ingress of dust and water)
- Wide range of operating temperature (down to  $-40^{\circ}\text{C}$  and up to  $+60^{\circ}\text{C}$ , for devices with extended temperature range)
- Visible red laser, laser class II (<0.95 mW)
- Configuration software available from Dimetix website ([www.dimetix.com](http://www.dimetix.com))
- Accessories for easy use of the sensor



**WARNING**

**Use of controls, adjustments or performance of procedures other than those specified in this Technical Reference Manual may result in hazardous radiation exposure.**



For easy starting with the D-Series sensors you can use our free configuration software "Laser Sensor Utility" from our website: [www.dimetix.com](http://www.dimetix.com).



### 3.1 Product identification

The Dimetix sensor products are identified by the label on the top of the sensors. The identification on the label shows the main properties of each sensor. It contains the sensor series, the sensor class, the temperature range, the accuracy and the maximum distance range. For more details see figure 5.

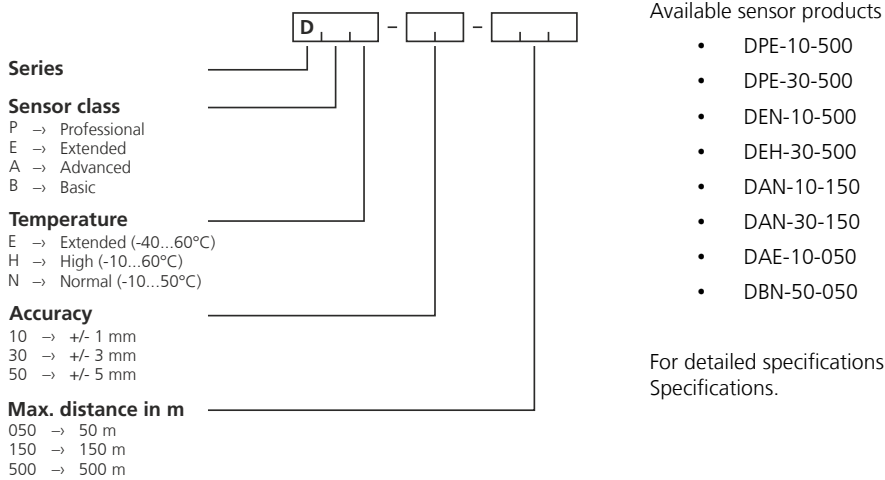

For detailed specifications of every sensor product, see 4.1 Specifications.

Figure 5: Product identification



## 3.2 Components

The components with some helpful detail information of the D-Series devices are marked in figure 6.

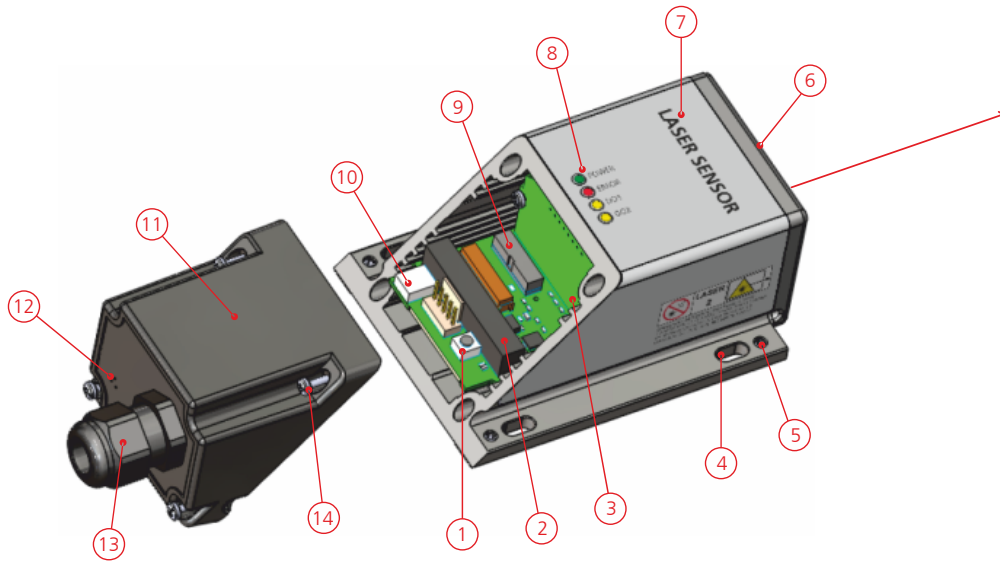

Figure 6: Sensor components with detail information

- |  |   |
|--|---|
| 1) Reset push button   | 8) Status LED's (Power, error, digital outputs)   |
| 2) Screw terminal block & plug. For conductor cross section 0.14...1.5 mm <sup>2</sup> . (Power supply, digital input / output, analog output, RS-232 and RS-422 / RS-485 / SSI) | 9) Industrial Ethernet interface  |
| 3) Shield tab for an adequate receptacle (Contact size: 2.8 x 0.5 mm)  | 10) USB 2.0 Mini-B  |
| 4) Slot hole for installation and alignment (M4 or M3 screws)  | 11) Exchangeable cover (Used for optional interfaces)   |
| 5) Hexagon socket set screw for sensor alignment   | 12) Valve diaphragm   |
| 6) Sensor front (Laser beam output and receiver lens)  | 13) Cable gland M16 x 1.5 mm (Cable diameter: 5...10 mm, tool size: 20 mm)                                      |
| 7) Product label (for more details, see in chapter 2.11)   | 14) Screws, Philips Slotted Combo (Philips size 1, slot size 2). The target torque for these screws is 1.6 Ncm. |



**NOTICE**

### Take precaution against electrostatic discharge (ESD) when exchangeable cover is open.

- Generally the sensor with removed exchangeable cover is a sensitive device and can be damaged by electrostatic discharge.
- Only handle the device properly grounded and with care.
- No warranty will be granted on improper handling and / or ESD caused problems.



The warranty is void if the device is opened except the exchangeable cover. Removing the label is also understood as opening.

## 3.3 Validity

This manual is valid for D-Series devices with the following software version:

- Interface software version: **V1.21 or later**
- Module software version: **V4.1 or later**

To get the software version use the command described in 8.5.1 Get software version (sNsv) on page 53.



## 4 Technical data

### 4.1 Specifications

	DPE-10-500	DPE-30-500	DEN-10-500	DEH-30-500	DAN-10-150	DAN-30-150	DAE-10-050	DBN-50-050
Part number	500630	500636	500637	500638	500632	500634	500633	500635
Typical measuring accuracy <sup>1) 2)</sup> @ 2 $\sigma$ (95.4% confidence level) @ 1 $\sigma$ (68.3% confidence level)	$\pm 1.0$ mm $\pm 0.5$ mm	$\pm 3.0$ mm $\pm 1.5$ mm	$\pm 1.0$ mm $\pm 0.5$ mm	$\pm 3.0$ mm $\pm 1.5$ mm	$\pm 1.0$ mm $\pm 0.5$ mm	$\pm 3.0$ mm $\pm 1.5$ mm	$\pm 1.0$ mm $\pm 0.5$ mm	$\pm 5.0$ mm $\pm 2.5$ mm
Typical repeatability <sup>1) 2)</sup> @ 2 $\sigma$ (95.4% confidence level) @ 1 $\sigma$ (68.3% confidence level)	$\pm 0.3$ mm $\pm 0.15$ mm	$\pm 0.7$ mm $\pm 0.35$ mm	$\pm 0.3$ mm $\pm 0.15$ mm	$\pm 0.7$ mm $\pm 0.35$ mm	$\pm 0.3$ mm $\pm 0.15$ mm	$\pm 0.7$ mm $\pm 0.35$ mm	$\pm 0.3$ mm $\pm 0.15$ mm	$\pm 1.8$ mm $\pm 0.9$ mm
Measuring range on natural surfaces <sup>3)</sup>	0.05...100 m	0.05...100 m	0.05...100 m	0.05...100 m	0.05...100 m	0.05...100 m	0.05...50 m	0.05...50 m
Measuring range on Dimetix orange (reflective) foil	0.5...500 m	0.5...500 m	0.5...500 m	0.5...500 m	~40...150 m	~40...150 m	- <sup>10)</sup>	- <sup>10)</sup>
Measuring reference	From front edge (see 4.2 Physical dimensions)							
Smallest unit displayed	0.1 mm							
Accuracy of analog output (12 Bit, programmable span)	$\pm 0.1\%$	$\pm 0.1\%$	$\pm 0.1\%$	-	$\pm 0.1\%$	$\pm 0.1\%$	$\pm 0.1\%$	$\pm 0.2\%$
Max. measuring rate <sup>1)</sup>	250 Hz	250 Hz	100 Hz <sup>11)</sup>	100 Hz <sup>11)</sup>	100 Hz <sup>11)</sup>	100 Hz <sup>11)</sup>	100 Hz <sup>11)</sup>	10 Hz
Max. output rate for tracking measurement <sup>1)</sup>	1 kHz	1 kHz	100 Hz <sup>11)</sup>	100 Hz <sup>11)</sup>	100 Hz <sup>11)</sup>	100 Hz <sup>11)</sup>	100 Hz <sup>11)</sup>	10 Hz
Typical time for a measurement <sup>1)</sup> Single measurement Tracking	0.05...4 s 0.004...4 s	0.05...4 s 0.004...4 s	0.05...4 s 0.01...4 s	0.05...4 s 0.01...4 s	0.05...4 s 0.01...4 s	0.05...4 s 0.01...4 s	0.05...4 s 0.01...4 s	0.1...4 s 0.1...4 s
Light source	Laser diode 620-690 nm (red, typical 655 nm), see chapter 2.7 Laser specification for details IEC 60825-1 Ed. 3; Class 2 FDA 21 CFR 1040.10 / 1040.11 and Laser Notice 56							
Typical laser life time	50'000 h @ 20°C (see 7.5 Laser life time consideration)							
Typical diameters (elliptic) of laser spot on target at a defined distance <sup>4)</sup>	4 mm / 2 mm @ 5 m; 7 mm / 3 mm @ 10 m; 17 mm / 9 mm @ 30 m; 28 mm / 13 mm @ 50 m; 55 mm / 30 mm @ 100 m							
Electromagnetic compatibility (EMC)	IEC/EN 61000-6-4 / 61000-6-3; IEC/EN 61000-6-2 / 61000-6-1							
Power supply Voltage range <sup>5)</sup> Current consumption (@ 24 VDC / 12 VDC) <sup>6)</sup>	12...30 VDC 0.5 A / 0.8 A	12...30 VDC 0.5 A / 0.8 A	12...30 VDC 0.15 A / 0.2 A	12...30 VDC 0.15 A / 0.2 A	12...30 VDC 0.15 A / 0.2 A	12...30 VDC 0.15 A / 0.2 A	12...30 VDC 0.5 A / 0.8 A	12...30 VDC 0.15 A / 0.2 A
Temperature range during operation <sup>7) 8)</sup>	-40...+60°C	-40...+60°C	-10...+50°C	-10...+60°C	-10...+50°C	-10...+50°C	-40...+60°C	-10...+50°C
Temperature range during storage	-40...+70°C							
Relative humidity (operation / storage)	up to 85% (RH), non-condensing							
Degree of protection	IP65							

4 Technical data

	DPE-10-500	DPE-30-500	DEN-10-500	DEH-30-500	DAN-10-150	DAN-30-150	DAE-10-050	DBN-50-050
	IEC 60529 (Protected against ingress of dust and water)							
Shock and vibration testings	IEC 60068-2-27 (Shock); IEC 60068-2-6 (Vibration)							
Dimensions	140 x 78 x 48 mm							
Weight	350 g							
Material	Aluminum Alloy EN-AW 6060 (Anodized 20um) Mineral reinforced nylon resin <sup>9)</sup>							
Main sensor body								
Sensor front & Standard exchangeable cover								
Standard integrated interfaces of sensor								
Analog output 0/4...20 mA	1	1	1	-	1	1	1	1
Digital output / Error output (programmable)	2 / 1	2 / 1	2 / 1	- / 1	2 / 1	2 / 1	2 / 1	2 / 1
Digital input (programmable)	1	1	1	1	1	1	1	1
RS-232	1	1	1	1	1	1	1	1
RS-422/485 with ID 0..99	1	1	1	1	1	1	1	-
SSI	1	1	1	1	1	1	1	-
USB	1	1	1	1	1	1	1	1
Possibility to install optional extended interfaces PROFINET / EtherNet/IP / EtherCAT	Yes	Yes	Yes	Yes	Yes	Yes	Yes	-

- <sup>1)</sup> The accuracy and measurement speed depend on the configuration of the measurement characteristic, see 6.3 Measuring characteristic and environmental conditions, see 7.3 Measuring performance influence.
- <sup>2)</sup> Confidence level description, see 4.3 Measuring accuracy definition according the ISO-recommendation ISO/R 1938-1:2015.
- <sup>3)</sup> Performance on natural surfaces depends on target reflectivity, background light and atmospheric conditions (see also 7.3 Measuring performance influence).
- <sup>4)</sup> The spot size can vary depending on production lot. Approximation about spot size: Increase about 0.6 mm / m for long and 0.3 mm / m for short diameter of laser spot ellipse.
- <sup>5)</sup> Voltage range 12...30 VDC can be extended to about 9...30 VDC but with limitations using analog output. If analog output is used consider the min. needed input voltage according the following guideline:  $V_{+min} \geq R_{AO\_LOADmax} * I_{AOmax} + 3.5 V$  (for more details see 5.6 Analog output).
- <sup>6)</sup> The current consumption of the device is defined without connected analog and digital outputs (AO, DO1, DO2 and DOE). The current consumption of analog and / or digital outputs has to be considered in addition.
- <sup>7)</sup> In case of permanent measurement (continuous distance measurement) the max. temperature during operation may be reduced.
- <sup>8)</sup> For D-Series devices with an optional Industrial Ethernet interface (exchangeable cover) the max. operating temperature is limited to +50°C.
- <sup>9)</sup> Material with high mechanical strength, excellent balance of stiffness/toughness, good temperature performance and chemical resistance
- <sup>10)</sup> Measuring on Dimetix orange (reflective) foil possible from at least approx. 40 m to maximum distance of 50 m.
- <sup>11)</sup> 100 Hz valid for production date 09/2022 or newer. Before this date 50 Hz.

### 4.2 Physical dimensions

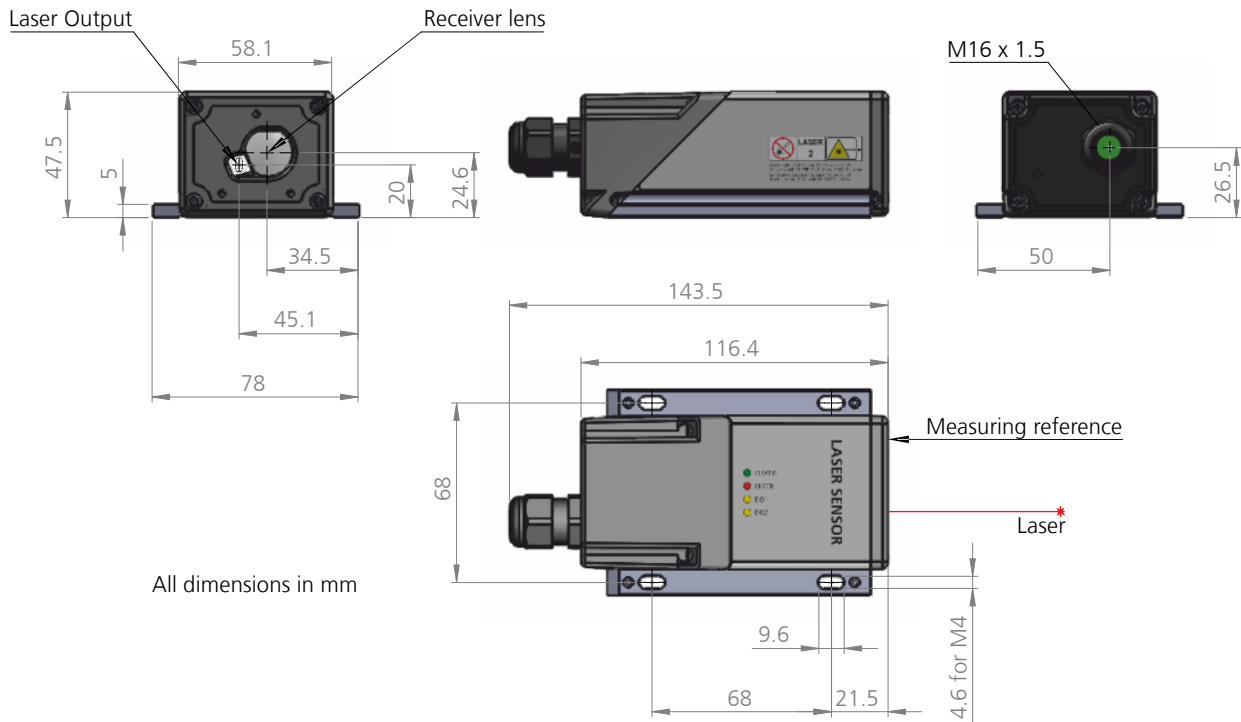

Figure 7: Physical dimensions of sensor

For CAD data of the D-Series sensors please check our website or contact us (Website and contact information see [www.dimetix.com](http://www.dimetix.com)).

### 4.3 Measuring accuracy definition

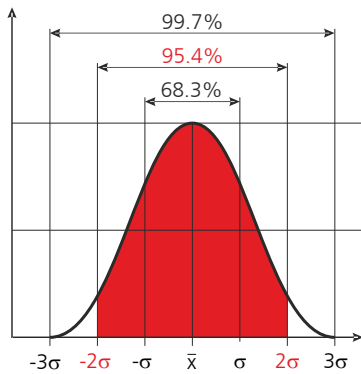

Figure 8: Measuring accuracy definition

The measuring accuracy corresponds to the ISO-recommendation ISO/R 1938-1:2015 with a statistical confidence level of 95.4% (i.e.  $\pm$  twice the standard deviation  $\sigma$ , see figure 8 on the left). The typical measuring accuracy relates to average conditions for measuring. It is  $\pm 1.0$  mm for the Dxx-10-xxx and  $\pm 3.0$  mm for the Dxx-30-xxx valid in the tracking mode.

Maximum deviation may occur under unfavorable conditions such as bright sunlight or when measuring to poorly reflecting or very rough surfaces. Measuring accuracy may deteriorate by approximately  $\pm 0.02$  mm/m for distances above 30m.

The D-Series laser sensors do not compensate changes of atmospheric environment. These changes can influence the accuracy if measuring long distances (>150 m) under conditions very different from 20°C, 60% relative humidity and 953 mbar air pressure. The influences of the atmospheric environment are described in H. Kahmen & W. Faig: "Surveying", (1988).

## 5 Electrical components

The main electrical components of the D-Series sensors are described in this chapter. The overview of the components are labeled in figure 9.

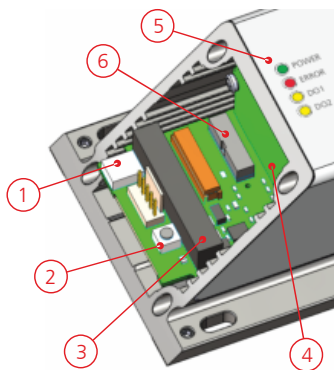

- 1) USB 2.0 Mini-B  
(see chapter 5.10 for details)
- 2) Reset push button  
(see chapter 5.2 for detailed reset process description)
- 3) Screw terminal block & plug (Pitch: 3.5 mm, conductor cross section: 0.14...1.5 mm<sup>2</sup>).  
(Power supply and sensor interfaces, see chapter 5.1, 5.4, 5.5, 5.6, 5.7, 5.8 and 5.9)
- 4) Shielding tab  
(suitable for receptacle, see chapter 5.1 for details)
- 5) Status LED's (POWER, ERROR, DO1, DO2)  
(see chapter 5.3 for detailed LED status)
- 6) Industrial Ethernet interface (Exchangeable cover)  
(see chapter 5.11 for details)

Figure 9: Overview electrical components

The connection overview of the screw terminal block & plug is shown in the following table. The power supply and all available sensor interfaces (Power, DI/DO's, AO, RS-232 and RS-422 / 485 / SSI) can be accessed.

#	Designation	Description	#	Designation	Description	#	Designation	Description
1	V+	Power supply VCC / V+	5	DOE	Digital error output	9	T-	RS-422 / 485 / SSI interface
2	GND	Power supply 0 V / V-	6	AO	Analog output (0 / 4...20 mA)	10	T+	
3	DO1	Digital output / input 1	7	RX	RS-232 interface	11	R-	
4	DO2	Digital output 2	8	TX		12	R+	



**NOTICE**

**Take precaution against electrostatic discharge (ESD) when exchangeable cover is open.**

- Generally the sensor with removed exchangeable cover is a sensitive device and can be damaged by electrostatic discharge.
- Only handle the device properly grounded and with care.
- No warranty will be granted on improper handling and / or ESD caused problems.

### 5.1 Power supply

#### 5.1.1 Specifications & Wiring

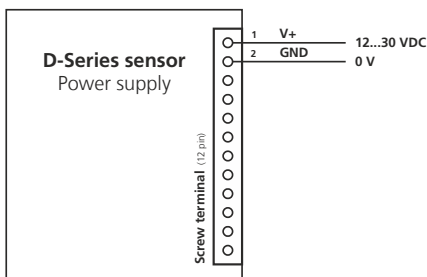

Figure 10: Connection of power supply (V+ and GND)

All the D-Series devices are overvoltage and reverse voltage protected. But for proper operation of the sensors consider the power supply requirements and the corresponding specifications.

Specifications for power supply:

- Voltage requirement: 12...30 VDC
- Current requirement: Depends on sensor type  
(for details see chapter 4.1)

The green status LED (POWER) indicates a powered and running device.

**NOTICE**

**Over voltage on power supply terminal can damage the device**

- Check wiring and nominal voltage of power supply before initial operation.



**NOTICE**

**Reverse polarity voltage on power supply terminals can damage the device**

- Check wiring before initial operation

**CAUTION**

**Only use high-quality power supply equipment and consider the voltage and current requirements of the D-Series sensors.**

**NOTICE**

- For trouble-free operation it's recommended to use a separate power supply for the sensors.

## 5.1.2 Shielding

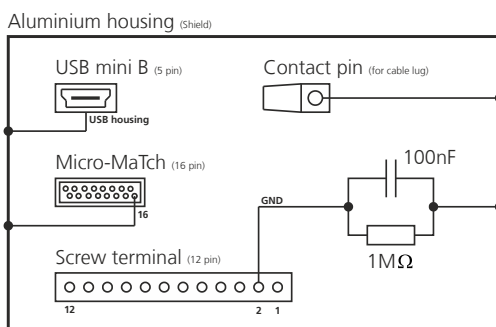

Figure 11: Shielding concept of the sensors

The shielding concept of the D-Series sensors is shown in figure 11. The aluminum housing of the sensor corresponds to shield and is also connected to the housing of the USB interface, to the Micro-MaTch connector and the shield tab. The shield tab can be used to connect the shield of a cable to the sensor shield (use an adequate receptacle).

The general GND of the device is connected to the shield / sensor housing by an R-C element (for details about the R-C element, see figure 11).

**NOTICE**

**Inadequate shielding can cause inexplicable interference of the sensor, the control system or other problems.**

- Implement a proper shielding concept .

## 5.2 Reset push button

The reset procedure sets the sensor configuration back to factory default (see 6.6 Factory settings). This also may helps if there is a problem with the sensor e.g. no communication over serial interfaces. The following steps show the reset procedure with the reset push button inside the D-Series sensors.

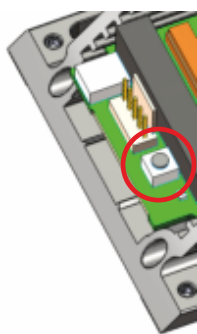

Figure 12: Reset push button















Reset procedure:

- 1) Switch off the power supply used for the device
- 2) Press the reset push button and keep it pressed
- 3) Switch on the power supply used for the device
- 4) Keep the reset push button pressed until all status LED's (POWER, ERROR, DO1, DO2) flash for a short time (about 0.5 seconds)
- 5) Release the reset push button
- 6) Switch off the power supply and wait 5 seconds
- 7) Switch on the power supply and wait until the green status LED (POWER) is on.
- 8) Reset procedure executed successfully



### 5.3 Status LED

The four status LED's (POWER, ERROR, DO1, DO2) on the top of the D-Series device show the operating status of the sensor and the digital outputs (DO1, DO2). The possible LED status with the appropriate status description and some useful references are described in the table below.

POWER	ERROR	DO1	DO2	Status of sensor – Description
				The device is powered and ready for operation → Normal sensor operation.
				The device is powered but an error occurred during the normal sensor operation. The error code is transmitted over the serial interfaces. For information about the error code number, see chapter 8.6.
				The device is powered and running → Normal sensor operation. One and / or both digital output (DO1, DO2) can be ON or OFF depending on the configured switching levels (for more details see chapter 5.4 and 6).
				Flash for about 0.5 seconds during reset procedure with the reset push button (see chapter 5.2)
				The device is in error state. See the error code on the serial interface and contact Dimetix if error persists after power cycle and reset. Normal case if power LED is off → Sensor supply voltage too low / high. For information about the error code number, see chapter 8.6.
				The device is ready for interface board firmware download. For the download procedure use the "Laser Sensor Utility" software. See the Dimetix website <a href="http://www.dimetix.com">www.dimetix.com</a> .

### 5.4 Digital output

The D-Series sensors contains two (or one) digital outputs (DO1 and DO2) for level monitoring and one digital output (DOE) for error signalization. These outputs can be configured as NPN, PNP or Push-Pull output type. The digital outputs are able to drive up to 150 mA and are specified for an output voltage of 30 VDC. The details about the output specifications and types are described in 5.4.1 Specifications.

#### 5.4.1 Specifications

	Properties / Possibilities		
Output voltage LOW (active) NPN, Push-Pull	0.2 V @ 10 mA (max.) 1.5 V @ 100 mA (max.) 2 V @ 150 mA (max.)		
Output voltage HIGH (active) PNP, Push-Pull	(V+) - 0.2 V @ 10 mA (max.) (V+) - 1.5 V @ 100 mA (max.) (V+) - 2 V @ 150 mA (max.)		
Output voltage OPEN (inactive, high impedance) NPN, PNP	12...30 VDC (max.)		
Output current	up to 150 mA		
Output slew rate	max. 40 V/μs		
Output types	<b>Types</b>	<b>Output ON</b>	<b>Output OFF</b>
	NPN	LOW (GND / 0 V)	OPEN (high impedance)
	PNP	HIGH (V+)	OPEN (high impedance)
	Push-Pull	HIGH (V+)	LOW (GND / 0 V)
Protections	Reverse polarity Over-voltage Current limited (max. 450 mA) Short circuit (thermal shutdown)		
Cable length <sup>1</sup>	< 30 m unshielded cable possible (indoor only) ≥ 30 m or outdoor use shielded cables only		

The typical connections for the configurable digital output types are shown in figure 13. The load marked in the figure is a place holder for a specific load for example a relay or indicator light. If the digital output signal of the D-Series sensor is used as a digital input signal e.g. for a PLC, the push-pull output has to be used. But it's also possible to use the NPN or PNP output type with an additional pull-up / pull-down resistor.

<sup>1</sup> Max. cable length of Digital Output (DO) interface depends on cable quality and ambient conditions



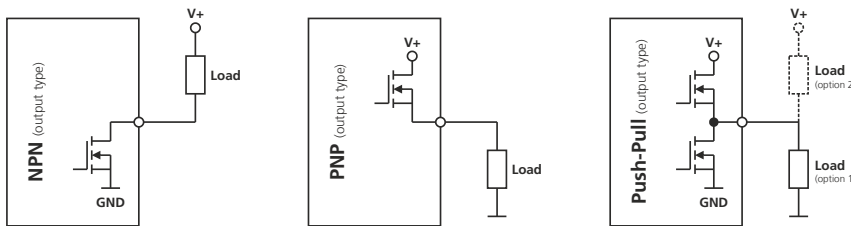

Figure 13: Digital output types (NPN, PNP, Push-Pull) with typical load connection

### 5.4.2 Wiring

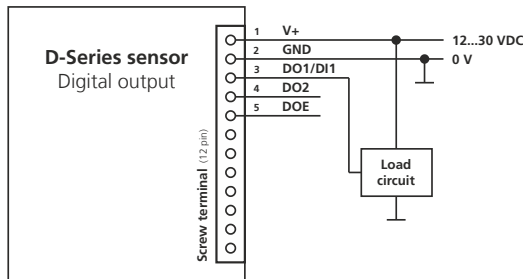

Figure 14: Connection for digital output (DO1, DO2, DOE)

The connection to use the digital outputs of the D-Series laser sensors is shown in figure 14 (example with DO1, analogous for DO2 and DOE outputs).

For detailed information about the load circuit, see the descriptions of the digital output types in chapter 5.4.1 and figure 13.

## 5.5 Digital input

The digital output (DO1/DI1) can also be used as digital input. This digital input allows triggering or start / stop measurements by an external digital signal. There are different configuration possibilities available, for more details see the configuration command 8.3.8 Set/Get digital input function (sNDI1).

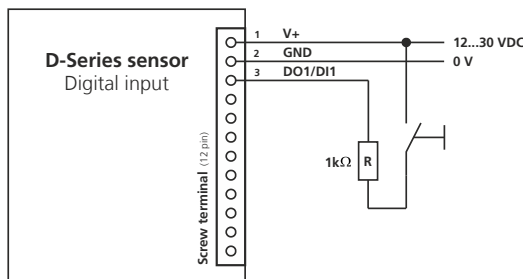

Figure 15: Connection of digital input for external triggering

Specifications for digital input signals:

- Low level:  $U_{DI1} < 2 \text{ VDC}$
- High level:  $9 \text{ VDC} < U_{DI1} < 30 \text{ VDC}$

To protect the digital input / output against short circuit always use a 1 kΩ resistor before DO1/DI1 terminal.

The connection and wiring to use the digital input is shown in figure 15.

### NOTICE

#### Improper wiring of digital input / output (DO1/DI1) can damage the sensor:

- Before initial operation configure input / output over USB or one of serial Interfaces, and check that wiring corresponds to the input/output configuration.

## 5.6 Analog output

The analog output of the D-Series sensors is a current source and is capable of driving loads up to 500 Ω. The current range is programmable to 0...20 mA or 4...20 mA. For more details see the specifications.

### 5.6.1 Specifications

	Properties / Possibilities
Potential / reference	No galvanic isolation (signal referenced to GND of the sensor)
Max. load resistance	$\leq 400 \Omega$ ( $\leq 500 \Omega$ with limitations) Generally the following guideline for min. device input voltage has to be considered: $V_{+min} \geq R_{AO\_LOADmax} * I_{AOmax} + 3.5 V$ (e.g. $V_{+min} = 500 \Omega * 20 mA + 3.5 V = 13.5V$ )
Accuracy	0.1% (of programmable distance span)
Resolution	12-Bit
Current range Minimum Maximum Error level	0 mA / 4 mA (programmable min. current level) 20 mA 0...20 mA (programmable)
Cable length <sup>1</sup>	$< 30 m$ unshielded cable possible (indoor only) $\geq 30 m$ or outdoor use shielded cables only

$$e_{Dist} = Accuracy_{Device} + \frac{(MaxDist_{Conf} - MinDist_{Conf}) * Accuracy_{AO}}{100}$$

$Accuracy_{Device}$	Device accuracy in mm
$MaxDist_{Conf}$	Configured max. distance in mm
$MinDist_{Conf}$	Configured min. distance in mm
$Accuracy_{AO}$	Accuracy of the analog output (e.g. 0.1 for 0.1%)
$e_{Dist}$	Total error in mm

#### Calculation example:

$$e_{Dist} = 1 mm + \frac{(10'000 mm - 0 mm) * 0.1}{100} = \pm 11 mm$$

#### DPE-10-500 (device specifications and configurations):

$Accuracy_{Device}$	$\pm 1 mm$
$MaxDist_{Conf}$	10'000 mm
$MinDist_{Conf}$	0 mm
$Accuracy_{AO}$	0.1%
$e_{Dist}$	<b><math>\pm 11 mm</math></b> (Calculation see left side)



The stated errors include all possible errors as temperature drift, linearity, surface color and measurement distance.



The best accuracy for the D-Series devices can only be achieved by using the digital serial interfaces (RS-232, RS-422/485, SSI or Industrial Ethernet).

### 5.6.2 Wiring

The connection of the analog output with a PLC (or other device) is shown in figure 16. Consider that the analog output of the D-Series sensors are not galvanic isolated and the GND (power supply 0 V) of the sensors are used for the analog output too.

<sup>1</sup> Max. cable length of Analog Output (AO) interface depends on cable quality and ambient conditions



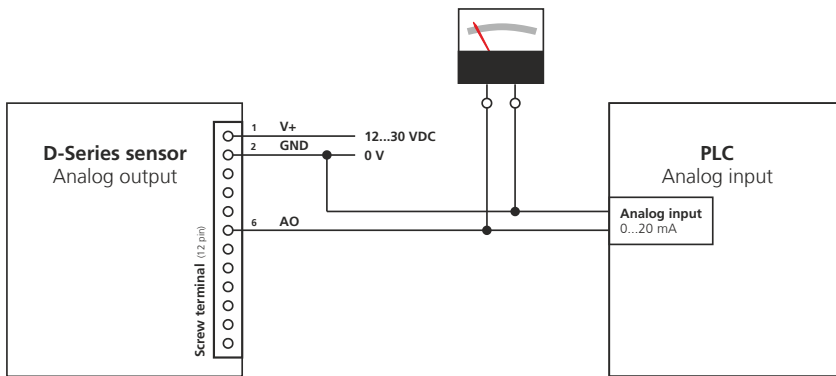

Figure 16: Connection of the analog output with a PLC (or other devices)

## 5.7 RS-232 interface

The RS-232 digital serial interface is mainly used for the device configuration. It allows the connection with a host (e.g. PC) to do the configuration with a terminal program (e.g. HTerm<sup>1</sup>, HyperTerminal<sup>2</sup>) or the Laser Sensor Utility software (for details see [www.dimetix.com](http://www.dimetix.com)).

The communication protocol is ASCII based, easy to understand and simple to use. For more details about the communication protocol and the available commands see 8 Command set on page 41. The factory settings of the RS-232 interface are specified in chapter 6.6 Factory settings.



Measurement rates faster than about 100 Hz are only possible if the baud rate is set to the maximum of 115'200 Baud. Lower baud rates reduce the measurement speed.

### 5.7.1 Specifications

The following specifications are in addition to the RS-232 standard specification (Standard specifications / guidelines are free available online).

	Properties / Possibilities
Voltage level	See RS-232 standard specifications / guidelines
Max. baud rate	115'200
Max. cable length (typical) <sup>3</sup>	≤ 15 m (unshielded cable for indoor use only)

### 5.7.2 Wiring

The connection of a D-Series sensor over the RS-232 interface with a host (e.g. PC or PLC) is shown in figure 17. With the RS-232 interface only point-to-point communication is possible.

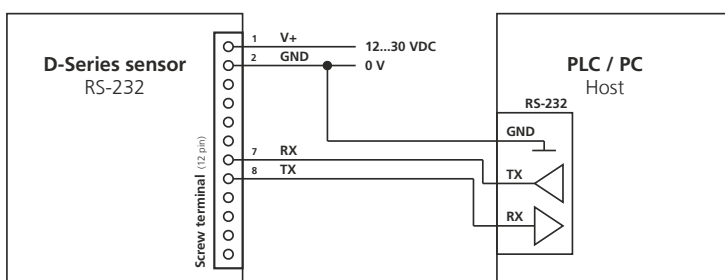

Figure 17: Connection of the RS-232 interface

1 HTerm is a free communication terminal software

2 HyperTerminal is a free communication terminal software from Microsoft (only available on Windows XP systems)

3 Max. cable length of RS-232 interfaces depend on communication speed, cable quality and ambient conditions





Never connect multiple D-Series devices on a single RS-232 line.

## 5.8 RS-422/485 interface

The RS-422/485 digital serial interface is made for industrial applications due to their robustness, max. cable length and the possibility of connection multiple devices on the same line. For this interface a shielded cable with twisted pairs for the data signals have to be used (see 5.8.1 Specifications for further information).

The communication protocol is unchanged and identical with the protocol for the RS-232 interface. For more details about the communication protocol and the available commands see 8 Command set on page 41. The factory settings of the RS-422/485 interface are specified in chapter 6.6 Factory settings.

It's important that the host has the control of the whole communication and never initiates a new communication before terminating the previous one (always waiting for the answer of the D-Series device or timeout).



The RS-422/485 interface cannot be used simultaneous with the SSI interface.



For more than one device on a single line, never use commands with continuous answers (e.g. single sensor tracking). Only use tracking with buffering (see 8.2.5 Tracking with buffering – Start (sNf)).



Measurement rates faster than about 100 Hz are only possible if the baud rate is set to the maximum of 115'200 Baud. Lower baud rates reduce the measurement speed.

### 5.8.1 Specifications

The following specifications are in addition to the RS-422/485 standard specifications. The standard specifications / guidelines are free available e.g. online..

	Properties / Possibilities
Voltage level	See RS-422/485 standard specifications / guidelines
Max. baud rate	115'200
Max. load for driver	$\geq 100 \Omega$
Cable characteristics Cable type Characteristic impedance $Z_0$ (typical)	Use shielded twisted pair cables only (twisted pairs: T+/T- and R+/R-) 100...150 $\Omega$ (typical)
Termination resistor $R_T$	100...150 $\Omega$ / 0.5 W (typical), should be equal to cable impedance $Z_0$
Cable length vs baud rate (typical) <sup>1</sup>	$\leq 500$ m $\rightarrow$ $\leq 200'000$ Baud (all baud rates possible) $\leq 1000$ m $\rightarrow$ $\leq 100'000$ Baud

### 5.8.2 Wiring RS-422

The connection of one or more D-Series devices (up to 100) over the RS-422 interface with a host (e.g. PC or PLC) is shown in figure 18. To use more than one D-Series sensor on a single RS-422 line the device ID of every device has to be configured with different ID's. Available and configurable ID's are form 0 to 99 (see 8.3.2 Set device ID (sNid)).

For proper operation use termination resistors  $R_T$  as shown in figure 18. The termination resistor should be equal to the cable impedance  $Z_0$  (typical 100...150  $\Omega$ ).

<sup>1</sup> Max. cable length of RS-422 / RS-485 interfaces depend on communication speed, cable quality and ambient conditions



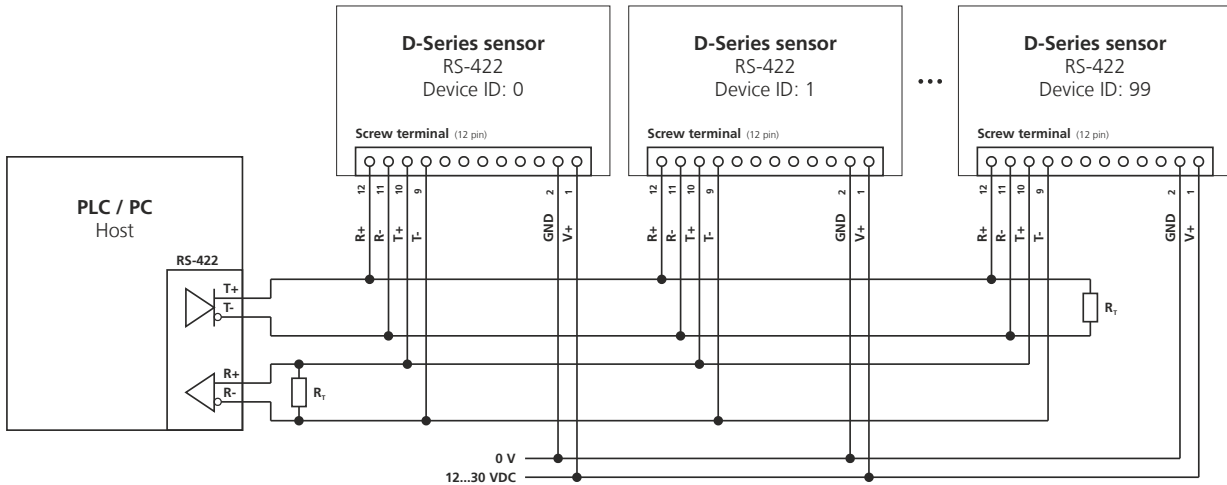

Figure 18: Connection of one or more RS-422 devices on one line,  $R_T$  → Termination resistors



If there are multiple devices on the same RS-422 line ensure that all devices have different device ID's.

**NOTICE**

**Using unshielded cables can cause communication problems or long term damage to the sensor**

- Use shielded twisted pairs cables only. For details see 5.8.1 Specifications.

**5.8.3 Wiring RS-485**

The connection of one or more D-Series devices (up to 100) over the RS-485 interface with a host (e.g. PC or PLC) is shown in figure 19. To use more than one D-Series sensor on a single RS-485 line the device ID of every device has to be configured with different ID's. Available and configurable ID's are from 0 to 99 (see 8.3.2 Set device ID (sNid)).

For proper operation use termination resistors  $R_T$  as shown in figure 19. The termination resistor should be equal to the cable impedance  $Z_0$  (typical 100...150  $\Omega$ ).

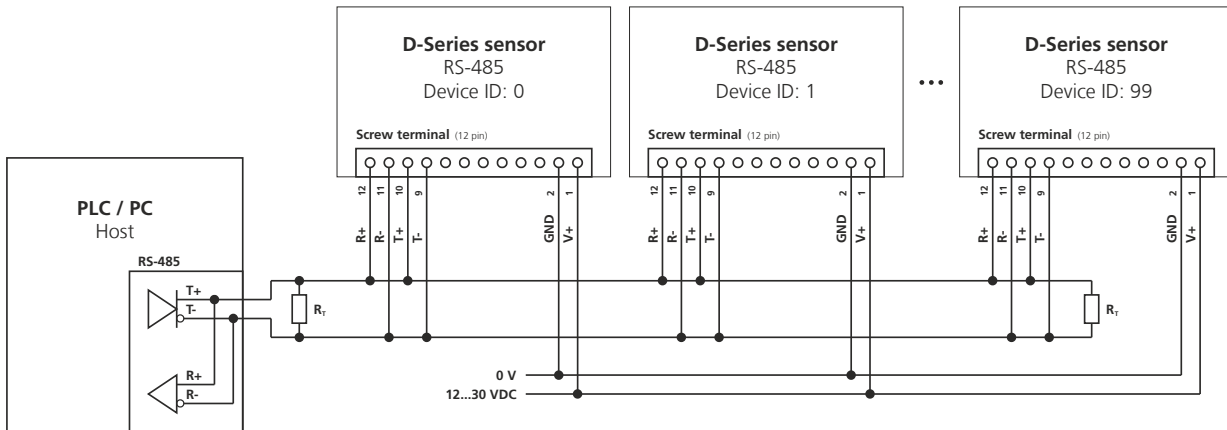

Figure 19: Connection of one or more RS-485 devices on one line,  $R_T$  → Termination resistors



If there are multiple devices on the same RS-485 line ensure that all devices have different device ID's.

**NOTICE**
**Using unshielded cables can cause communication problems or long term damage to the sensor**

- Use shielded twisted pairs cables only. For details see 5.8.1 Specifications.

## 5.9 SSI interface

The SSI interface is also made for industrial applications due to their synchronous communication, the robustness (because of differential signals) and max. possible cable length. For this interface a shielded cable with twisted pairs for the data signals have to be used (see 5.9.1 Specifications for further information).

It's possible to configure the SSI interface with different data formats / sizes, data coding (Binary or gray) and some other options. For detailed information see the configuration command in chapter 8.3.10 Set/Get configuration of RS-422/485 and SSI (sNSSI) and 8.3.11 Set/Get error value of SSI output (sNSSle). The factory settings of the SSI interface are specified in chapter 6.6 Factory settings.



The SSI interface cannot be used simultaneous with the RS-422/485 interface.

### 5.9.1 Specifications

	Properties / Possibilities
Distance output values	0...16777215 1/10 mm (max. 1.67 km)
Resolution	0.1 mm
Data coding	Binary or gray, MSB first (configurable)
Data format / size Distance data State / Error data	23 / 24-Bit (configurable) 0 / 1-Bit error state (configurable) 0 / 8-Bit error code (configurable)
Error value behavior	-2 / -1 / 0...16777215 (configurable)
Read out rate	≤ 1 kHz
Clock frequency (Clock from master device)	83 kHz to 1 MHz, depending on cable length
Pause time $t_p$ (Time lag between two data packets)	≥ 1 ms
Monoflop time $t_m$	25 μs
Voltage level	See RS-422/485 guidelines (differential signals)
Cable characteristics	Use shielded twisted pair cables only (twisted pairs: T+/T- and R+/R-)
Cable length vs data rate (typical) <sup>1</sup>	≤ 100 m → ≤ 1000 kBit/s ≤ 200 m → ≤ 600 kBit/s ≤ 500 m → ≤ 200 kBit/s ≤ 1000 m → ≤ 100 kBit/s

### 5.9.2 Timing

The timing of the SSI interface is shown in figure 20 and described below the figure.

<sup>1</sup> Max. cable length of SSI interfaces depend on communication speed, cable quality and ambient conditions



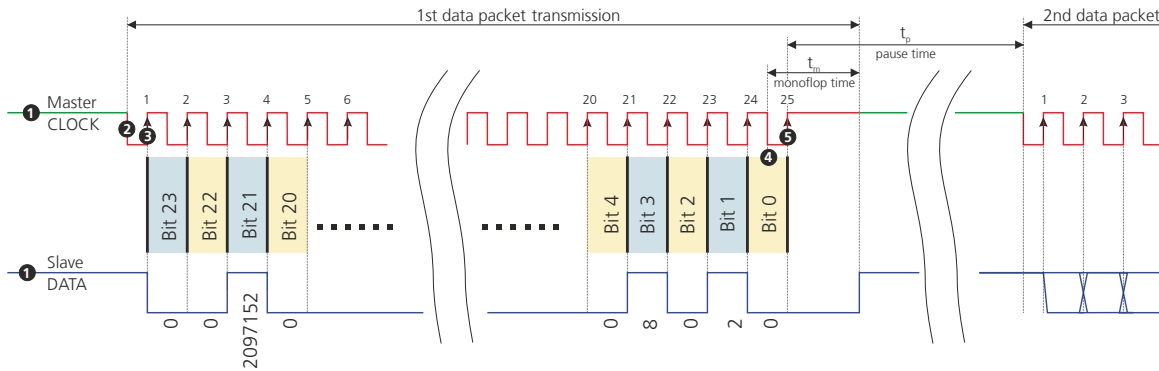

Figure 20: Timing diagram of SSI interface ( $t_m$  → Monoflop time,  $t_p$  → Pause time).

The SSI is initially in the idle mode, where the DATA and CLOCK lines stay HIGH ① and the slave keeps updating its internal data. The transmission mode is evoked when the master initiates a sequence by pulling the CLOCK line to LOW. Once, the slave receives the resulting falling edge ② at the CLOCK signal line, it automatically stops updating its internal data. With the first rising edge ③ at the CLOCK line, the MSB of the sensor data is transmitted and with consequent rising edges, the data bits are sequentially transmitted over the DATA line.

After the transmission of the complete data word ④ (e.g. LSB is transmitted), an additional last rising edge ⑤ at the CLOCK line sets the CLOCK to HIGH. The slave sets or leaves the DATA line to LOW and remains there for the monoflop time  $t_m$ , to recognize the transfer timeout.

If a falling edge at the CLOCK line (Data-Output request) is received within the monoflop time  $t_m$ , the same data as before will be transmitted again (*Multiple transmission*).

If there were no clock pulses within the monoflop time  $t_m$ , the slave starts updating its internal data after setting the DATA line to HIGH (Idle mode). This marks the end of the data word transmission (*Single transmission*). Once the slave receives a clock signal at a time  $t_p$  ( $\geq t_m$ ), the updated position data is frozen and the transmission of the new data begins as described earlier.

### 5.9.3 Wiring

The connection of the D-Series devices to use the SSI interface with a SSI master (e.g. PLC) is shown in figure 21. For details about the cable characteristics and the possible cable length (depends on data rates) see the specifications in chapter 5.9.1. The data rates must be set at the SSI master side.

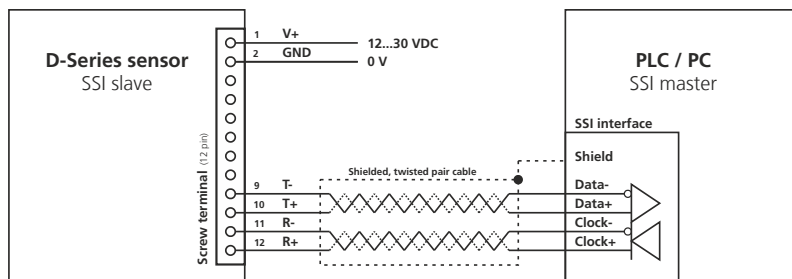

Figure 21: Connection of SSI interface with a master device



Never connect multiple D-Series devices on a single SSI line.

#### NOTICE

**Using unshielded cables can cause communication problems or long term damage to the sensor**

- Use shielded twisted pairs cables only. For details see 5.8.1 Specifications

## 5.10 USB interface

The USB interface is also mainly used for the device configuration. It allows the connection with a USB host (e.g. PC) to do the configuration with a terminal program (e.g. HTerm<sup>1</sup>, HyperTerminal<sup>2</sup>) or the Laser Sensor Utility software (for more details see [www.dimetix.com](http://www.dimetix.com)).

<sup>1</sup> HTerm is a free communication terminal software

<sup>2</sup> HyperTerminal is a free communication terminal software from Microsoft (only available on Windows XP systems)



The communication protocol is ASCII based, easy to understand and simple to use. It's the same protocol used for all configuration and other serial interfaces (RS-232, RS-422/485 and USB). For more details about the communication protocol and the available commands see 8 Command set on page 41.

### 5.10.1 Specifications & Wiring

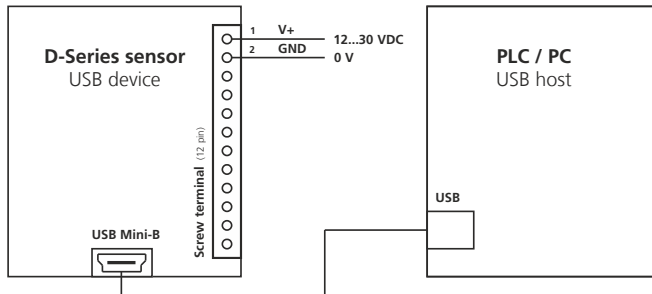

Figure 22: Connection of USB interface

Specifications for USB interface:

- USB Mini type B
- USB 2.0 FS (Full speed, max. 12 Mbps)
- Virtual COM port for D-Series device
- D-Series devices are not powered over USB interface (use separate power supply for the sensors)
- For other information not mentioned at this point, see the USB specifications and guidelines

The connection and wiring to use the USB Mini-B interface is shown in figure 22.

### 5.10.2 Installation

The USB interface of the D-Series laser sensor needs a basic USB driver installed on the host system. This has to be done only one time. If the driver installation was successful the D-Series laser sensor will be identified correctly by the host system. For downloading the USB driver please see the Dimetix website [www.dimetix.com](http://www.dimetix.com).

The D-Series laser sensor is identified as a virtual COM port device with the device name "D-Series USB Serial Port (COMxx)". Check the device manager for the COM port number. This number is required to connect to the sensor with a terminal program or the Dimetix Laser Sensor Utility software (for more details see [www.dimetix.com](http://www.dimetix.com)). The baud rate is the same as the baud rate configured for the other serial interfaces (RS-232 and RS-422/485).



Only use the Dimetix USB driver in conjunction with the D-Series USB port. Use the same baud rate for the USB interface as for the other serial interfaces (RS-232 and RS-422 / 485).

## 5.11 Industrial Ethernet interface

The Industrial Ethernet interface extends the available interfaces with PROFINET®, EtherNet/IP™ or EtherCAT®. These optional interfaces are designed as exchangeable covers and can be connected (over the Industrial Ethernet interface connector) and attached to the back of the D-Series sensors. The D-Series laser sensor is configurable in its entirety over the Industrial Ethernet interface. For detailed information about the available Industrial Ethernet interfaces, see the corresponding technical reference manual on the Dimetix website [www.dimetix.com](http://www.dimetix.com).

### 5.11.1 Specifications

	Properties / Possibilities
Industrial Ethernet protocol (For detailed specifications see the technical reference manual of the Industrial Ethernet)	PROFINET® EtherNet/IP™ EtherCAT®
Control and configuration	Over Industrial Ethernet - Cyclic process data (Control of D-Series laser sensor) - Acyclic parameter / data (Configuration of D-Series laser sensor)
Cable and connector	20 pin ribbon cable to connect exchangeable cover Use only original Dimetix connector cable and connector assembly.

### 5.11.2 Wiring

The connection of the D-Series device to use the Industrial Ethernet interface with the exchangeable cover is shown in figure 23. To use the exchangeable cover with one of the Industrial Ethernet protocol (PROFINET®, EtherNet/IP™ or EtherCAT®) all other sensor connectors and interfaces have to be disconnected otherwise the sensor may damage.



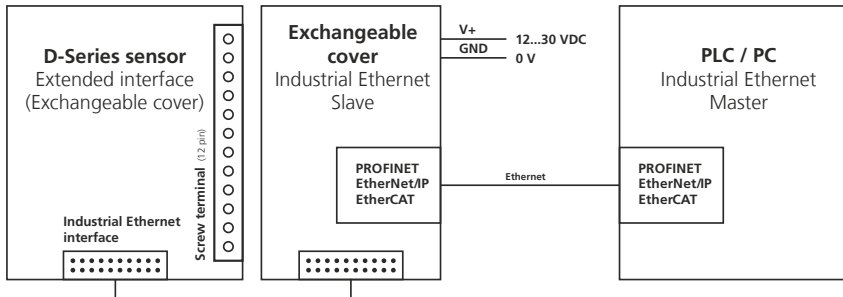

Figure 23: Connection of the exchangeable cover for Industrial Ethernet interfaces

**NOTICE**

**Connecting the exchangeable cover for Industrial Ethernet to the sensor under voltage may damage one of these components.**

- Switch of the power supply before connecting the exchangeable cover for Industrial Ethernet to the sensor
- No warranty will be granted on improper handling.

**NOTICE**

**Connecting the exchangeable cover for Industrial Ethernet simultaneously with one of the other interfaces of the sensor may damage one of these components.**

- Disconnect all other interface cables before connecting the exchangeable cover for Industrial Ethernet to the sensor.



Only use the original Dimetix flat ribbon cable to connect the D-Series Sensor with the exchangeable cover for Industrial Ethernet.

## 6 Configuration

The D-Series sensors have a multiplicity of configuration options. On the one hand the integrated interfaces can be configured (e.g. baud rate of the serial interfaces) to reach a wide range of application requirements. Otherwise it's also possible to configure the behavior of the sensors (e.g. measurement characteristic).

The following table shows an overview of all configuration options and the corresponding references to the commands or chapters.

Interfaces / Features	Configuration possibilities	Commands
Digital input	Input functions (Trigger single measurement, trigger tracking, etc.)	8.3.8 Set/Get digital input function (sNDI1)
Digital output	Output type (NPN, PNP, Push-Pull)	8.3.6 Set/Get digital output type (sNot)
	Hysteresis level (ON, OFF), data source (Distance, speed, signal or temperature) and function (single hysteresis or pulse) configuration (see description in chapter 6.5)	8.3.7 Set/Get digital output hysteresis (sN1, sN2) 8.4.6 Set/Get additional digital output configuration (sNado)
Analog output	Distance range (min. and max.) for 0/4...20 mA	8.3.5 Set/Get analog output distance range (sNv)
	Min. current level 0 mA or 4 mA	8.3.3 Set/Get analog output min level (sNvm)
	Current level in error case	8.3.4 Set/Get analog output value in error case (sNve)
RS-232, RS-422 / RS-485	Communication settings (Baud rate, etc.)	8.3.1 Set communication settings (sNbr)
	Sensor ID	8.3.2 Set device ID (sNid)
SSI	Communication settings (Data format, coding, etc.)	8.3.10 Set/Get configuration of RS-422/485 and SSI (sNSSI)
	Error behavior	8.3.11 Set/Get error value of SSI output (sNSSle)
Industrial Ethernet	Configuration over Industrial Ethernet interface	-
Sensor behavior	Operation mode (see description in chapter 6.2)	8.3.14 Set/Get auto start configuration (sNA) 8.4.4 Set/Get user mode (sNum)
	Measurement characteristic (see description in chapter 6.3)	8.3.12 Set/Get measuring characteristic (sNmc)
	Data output (Filter, gain, offset, format) (see description in chapter 6.4)	8.3.13 Set/Get measurement filter configuration (sNfi) 8.4.2 Set/Get user distance offset (sNuof) 8.4.3 Set/Get user distance gain (sNuga) 8.4.1 Set/Get user output format (sNuo) 8.4.5 Set/Get additional measurement filter configuration (sNafi)

### 6.1 Configuration process

The configuration process describes how the sensors can be configured. There are different interfaces for connection available and also two configuration types. The configuration example in 6.1.3 shows a possible analog output configuration and gives an impression of the configuration process.

#### 6.1.1 Connection

To be able to configure a D-Series device it has to be powered and connected to a host (usually a PC). On the host side a terminal program (e.g. HTerm<sup>1</sup>, HyperTerminal<sup>2</sup>) can be used to communicate with the sensor. A configuration utility software is also available on the Dimetix web page (see Laser Sensor Utility software at [www.dimetix.com](http://www.dimetix.com)).

Connections available for configuration (see figure 24 for details):

- 1) RS-232 interfaces
- 2) USB interface

<sup>1</sup> HTerm is a free communication terminal software

<sup>2</sup> HyperTerminal is a free communication terminal software from Microsoft (only available on Windows XP systems)



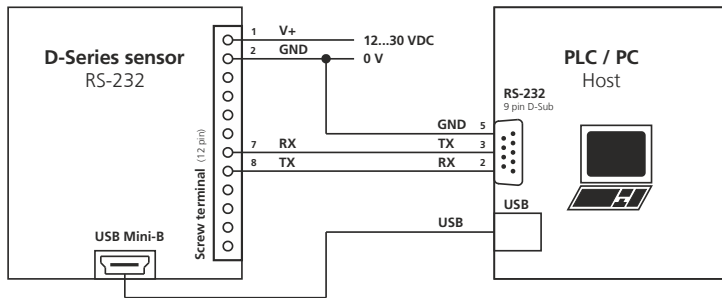

The specifications for the RS-232 or the USB interface are described in 5.7 RS-232 interface or 5.10 USB interface. The connection for using the RS-232 or the USB interface for configuration is shown in figure 24.

**RS-232 / USB default settings of the D-Series device:**

COM port: depends on PC / PLC<sup>3</sup>  
 Baud rate: 19'200 Baud  
 Data bits: 7  
 Parity: Even  
 Stop bits: 1

Figure 24: Connection of the RS-232 or USB interface for sensor configuration

### 6.1.2 Configuration types

The D-Series sensors can be configured with or without saving the configuration changes in the internal memory by using the save command (see 8.3.16 Save configuration parameters (sNs)). So there exist two types of using the configurations, volatile or non-volatile. To find out what configuration type should or can be used for a specific application see the description below.

The D-Series sensors support two configuration types (volatile and non-volatile, see the table below):

- Volatile (after every power up cycle, the configuration will be set)
- Non-volatile (only one-time configuration, the configuration will be set and saved in sensor memory)

Steps		Volatile	Non-volatile
<b>Power up</b>			
Configuration	1	Configuration (all used features)	Configuration (all used features)
	2	- (no save, volatile configuration)	Save configuration (save configuration in sensor memory)
Measurement	3	Measurement 0	Measurement 0
	4	Measurement 1	Measurement 1
	5	...	...
	n	Measurement n	Measurement n
<b>Power down</b>			
<b>Power up</b>			
Configuration	1	Configuration (all used features)	- (not required)
Measurement	2	Measurement 0	Measurement 0
	3	Measurement 1	Measurement 1
	4	...	...
	n	Measurement n	Measurement n

### 6.1.3 Configuration example

The configuration example in the table below shows the differences of the volatile and non-volatile configuration type on the basis of the analog output. The analog output will be configured to 4...20 mA for the distance range of 0...10 m. In error case, the analog output level has to be 0 mA.

<sup>3</sup> The serial COM port number depends on host system. Check the serial COM port number in the device manager of the host system.



Steps		Volatile	Non-volatile	Description
<b>Power up</b>				
Configuration	1	s0vm+1 s0v+0+100000 s0ve+0	s0vm+1 s0v+0+100000 s0ve+0	→ Set min. current level to 4 mA → Set distance range to 0...10 m (for 4...20 mA) → Set current level in error case to 0 mA
	2	-	s0s	→ s0s for saving configuration in sensor memory
Measurement	3	s0g	s0g	→ s0g for single distance measurement and update of analog output
	n	...	...	
<b>Power down</b>				
<b>Power up</b>				
Configuration	1	s0vm+1 s0v+0+100000 s0ve+0	-	→ New configuration if not saved before power down (only for volatile configuration type)
Measurement	2	s0g	s0g	
	n	...	...	

## 6.2 Operation modes

The D-Series laser sensors offer two types of operation modes, the controlled mode and the stand-alone mode to cover a wide range of applications. While the controlled mode provides maximum flexibility and needs to be triggered by a host system, the stand-alone mode can operate autonomously. Often it's not suitable or welcome to control a device by the host system in an existing environment. In such cases the stand-alone mode might be preferred. The two types of operation modes are described in the table below.

Controlled mode	Stand-alone mode	
	Auto start	Manual start
The distance measurement is controlled / triggered by a host system. The available commands are listed below: <ul style="list-style-type: none"> <li>sNg → Distance measurement</li> <li>sNh → Single sensor tracking</li> <li>sNf → Tracking with buffering</li> </ul>	The distance measurement starts automatically after a power on cycle. The available commands are listed below: <ul style="list-style-type: none"> <li>sNA → Auto start configuration</li> <li>sNum → User mode configuration</li> </ul>	An external signal triggers distance measurements. This is possible by configuring the digital input DI1. The available command is listed below: <ul style="list-style-type: none"> <li>sNDI → Digital input functions</li> </ul>
See 6.2.1 Controlled mode for more details.	See 6.2.2 Stand-alone mode for more details.	See 6.2.2 Stand-alone mode for more details.

All interfaces of the laser sensor are updated internally (with new distance measurements or error codes) independently of the operation mode.

### 6.2.1 Controlled mode

In controlled mode each action / operation of the D-Series sensor is triggered by a command sent from a host system over a serial interface (RS-232, RS-422 / 485 or USB). The basic configuration steps to use the controlled mode are listed in the table below.

Steps	Action	Description	Commands
1	Clear device	Clear the device before using the controlled mode by doing a clear followed by a save command.  It's also possible to do a device reset (Factory default of the laser sensor)	8.2.1 Stop / Clear command (sNc) 8.3.16 Save configuration parameters (sNs)  5.2 Reset push button
2	Set communication parameters	Configure the desired communication parameters and device ID.	8.3.1 Set communication settings (sNbr) 8.3.2 Set device ID (sNid)
3	Operation	Use the operation commands to do distance measurements or to use other sensor functionality.	8.2 Operation commands

For this operation mode a host software is required to control the D-Series laser sensor. Check the Dimetix website for software sample code or Application Notes (see [www.dimetix.com](http://www.dimetix.com)). Careful testing of the host software together with the device is strongly recommended prior to installation.

### 6.2.2 Stand-alone mode

The stand-alone mode is grouped in auto start configuration and manual start configuration. For details about the functionality and the configuration steps see the following sections.



### Auto start configuration

The following steps are needed to configure the D-Series device for the stand-alone mode with auto start configuration. In this mode the distance measurement is started automatically after every power-up cycle. No external trigger or command is required to start measurement. All sensor interfaces are updated internally with distance or error data. For the default auto start configuration there is no serial output on the RS-232, RS-422/485 and USB interface. Optionally this output can also be activated by the user mode configuration command. See the configuration steps in the table below.

Steps	Action	Description	Commands
1	Clear device	Clear the device before using the stand-alone mode by doing a clear followed by a save command. It's also possible to do a device reset (Factory default of the laser sensor).	8.2.1 Stop / Clear command (sNc) 8.3.16 Save configuration parameters (sNs) 5.2 Reset push button
2	Set user mode	Do this step if auto start configuration with serial output on RS-232, RS-422/485 and USB interface is required (User mode 2 to activate serial output).	8.4.4 Set/Get user mode (sNum)
3	Set the auto start configuration	Configure the D-Series device to the stand-alone mode with auto start. It's possible to select a desired sample rate. For more details see the command description.	8.3.14 Set/Get auto start configuration (sNA)

### Manual start configuration

The following steps are needed to configure the D-Series device for the stand-alone mode with manual start configuration. In this mode the distance measurement can be triggered by an external signal event on the digital input (DI1). There are different actions of the D-Series laser sensor available. All sensor interfaces are updated internally with distance or error data.

Steps	Action	Description	Commands
1	Clear device	Clear the device before using the stand-alone mode by doing a clear followed by a save command. It's also possible to do a device reset (Factory default of the laser sensor)	8.2.1 Stop / Clear command (sNc) 8.3.16 Save configuration parameters (sNs) 5.2 Reset push button
2	Set the digital input function	Configure the D-Series device to react on a trigger event on the digital input (DI1) with a distance measurement. There are different actions available. For more details see the configuration command.	8.3.8 Set/Get digital input function (sNDI1)
3	Save configuration	The save configuration command stores this configuration in a non-volatile memory. The configuration persist in the device after a power cycle.	8.3.16 Save configuration parameters (sNs)

### 6.2.3 Error behavior

In case of a device, configuration or measurement error the D-Series laser sensor show the error on the available sensor interfaces (Status LED's, analog output, digital outputs, RS-232, etc.). On the configurable interfaces the error code is transmitted according this configuration.

The error will be automatically cleared after another successful distance measurement, performing a stop / clear command (see chapter 8.2.1 Stop / Clear command (sNc)) or a power cycle.

The D-Series devices automatically store the occurred measurement errors in a non-volatile error stack. After power-cycle the last errors are still available for diagnostic purpose. The error stack can be read or cleared with the Read/Clear error stack (sNre, sNce) command. For more details about the command, see chapter 8.2.9.

## 6.3 Measuring characteristic

Multiple measuring characteristics are available in the D-Series measuring devices to meet different requirements for various applications. With these measuring characteristics measuring rate and accuracy can be optimized for specific application requirements.

The available measurement characteristic with the main properties (measuring rate and typical accuracy) are described in the table below. These characteristics can be configured for all D-Series devices except the DBx-xx-xxx type. Please consider for the DBx-xx-xxx only the *Normal* measurement characteristic is available.



Measuring characteristic		Max. measuring rate / output rate		Typical accuracy @2 $\sigma$		Description
No.	Name	DPx-xx-xxx	DAx-xx-xxx DEx-xx-xxx	Dxx-10-xxx	Dxx-30-xxx	
0	Normal	20 Hz <sup>1) 2)</sup>	20 Hz <sup>1) 2)</sup>	$\pm 1$ mm	$\pm 3$ mm	Normal measuring characteristic covers a wide range of applications. Measuring range on natural surface: Typical up to 100 m (depends on device type, see the specifications in 4.1). Configuration command: sNmc+0 <sup>3)</sup>
1	Fast	250 Hz <sup>1) 2) 5)</sup>	100 Hz <sup>1) 2) 6)</sup>	$\sim \pm 1.5$ mm	$\sim \pm 4.5$ mm	Increase measuring rate up to 100 Hz / 250 Hz (depends on device type, see the specifications in 4.1). Configuration command: sNmc+1 <sup>3)</sup>
2	Precise	10 Hz <sup>1) 2)</sup>	10 Hz <sup>1) 2)</sup>	$\sim \pm 0.8$ mm	$\sim \pm 2.4$ mm	Increase accuracy with longer measurement to $\sim \pm 0.8$ mm / $\sim \pm 2.4$ mm (depends on measuring conditions). To generally increase measuring performance, consider 7.3 Measuring performance influence. Configuration command: sNmc+2 <sup>3)</sup>
3	Timed	User programmed 250 Hz <sup>2) 5)</sup>	User programmed 100 Hz <sup>2) 6)</sup>	variable	variable	Timed measuring characteristic allows user defined measuring rates. The device does not consider measuring conditions to reach the specified accuracy. The measuring rate is fixed and the accuracy is variable (depends on measuring conditions). Configuration command: sNmc+3 <sup>3)</sup>
4	Moving target	250 Hz / 1 kHz <sup>4) 5)</sup>	100 Hz <sup>6)</sup>	$\pm 1$ mm	$\pm 3$ mm	Moving target measuring characteristic is specific designed for measurements on fast continuous moving targets. For reliable measuring results a good measuring signal is mandatory (good measuring conditions). Target speed up to 10 m/s. Configuration command: sNmc+4 <sup>3)</sup>
5	Not used	-	-	-	-	-

- <sup>1)</sup> The measuring rate depends on environmental conditions such as target surface, distance, background light (e.g. sun light), for more details see 7.3 Measuring performance influence. For good conditions (e.g. white target surface or Dimetix orange reflective target plate and dark environment) the specified max. measuring rate can be reached. For bad conditions the measuring rate decrease.
- <sup>2)</sup> For all measuring characteristic instead of Moving Target the output rate is identical to the measuring rate. After every measurement the output will be updated.
- <sup>3)</sup> For more details about the configuration command, see 8.3.12 Set/Get measuring characteristic (sNmc).
- <sup>4)</sup> Output rate is fixed to 250 Hz for serial interfaces, 500 Hz for Industrial Ethernet and 1 kHz for SSI, analog output and digital outputs.
- <sup>5)</sup> Note that for measuring rates above about 100 Hz, the maximum baud rate 115'200 must be used for the serial interfaces (RS-232, RS-422/485), otherwise the measuring speed will be reduced.
- <sup>6)</sup> 100 Hz valid for production date 09/2022 or newer. Before this date 50 Hz.



## 6.4 Data output

The data output of the D-Series device is configurable with a wide range of possibilities (output format, user gain, user offset and some filter options). The details about the available configurations are described in the following chapters.

The figure 25 gives an overview of the configuration possibilities and shows the effect on the D-Series device interfaces. Please consider not all interfaces are affected in the same manner. For example, the user output format and user gain / offset are only available on the serial interfaces RS-232, RS-422/485 and USB.

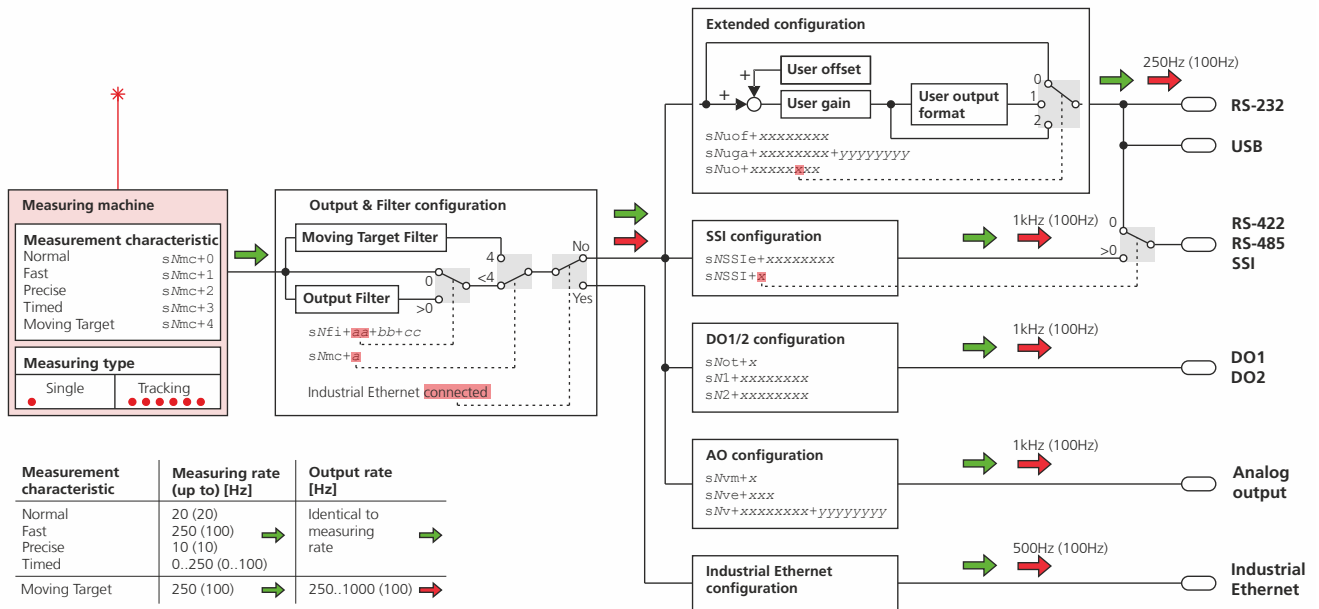

Figure 25: Configuration possibilities and flow chart of data output. Colored arrows show the interface update rate depending on the available measurement characteristics. The measuring and output rates without parenthesis are for DPx-xx-xxx device types. The measuring and output rates with parenthesis are for DAx-xx-xxx and DEx-xx-xxx device types. Please see also the specifications in chapter 4.1 for the corresponding sensor type. Note that for measuring rates above about 100 Hz, the maximum baud rate 115'200 must be used for the serial interfaces (RS-232, RS-422/485), otherwise the measuring speed will be reduced.

### 6.4.1 User output format / protocol

The configurable output format / protocol of the D-Series laser sensor allows the connection of an external ASCII display, to add some additional measurement information or the possibilities to set an individual user distance offset and / or user gain. The user output format is only available on the serial interface RS-232, RS-422/485 and USB.

The configuration command sNuo can be used to select the desired output format and to set some additional settings used for the external ASCII display (field length and position of decimal point). For more details see 8.4.1 Set/Get user output format (sNuo) and check the Dimetix website for appropriate Application Notes (see [www.dimetix.com](http://www.dimetix.com)).

The available output format with an example are listed below:

- Default output format (Factory default)
- Display output format (For external ASCII display, not applicable for RS-485)
- Default format with user offset / gain active
- Extended distance format with signal and temperature data and user offset / gain active
- Extended distance format with signal, temperature and speed data and user offset / gain active

#### Configuration example

Configuration example	Output
sNuo+0 (User offset / gain configuration ignored)	"gNg+00012345\r\n"
sNuo+139, sNuga+1+10, sNuof+0 (User offset / gain configuration considered)	" 1.234"
sNuo+200, sNuga+1+1, sNuof-10000 (User offset / gain configuration considered)	"gNg-00002345\r\n"
sNuo+300, sNuga+1+1, sNuof+0 (User offset / gain configuration considered)	"gNg+00012345+0083 84+254\r\n"
sNuo+301, sNuga+1+1, sNuof+0 (User offset / gain configuration considered)	"gNg+00012345+0083 84+254+000500\r\n"



The user output format is only available on the serial interface RS-232, RS-422/485 and USB. The display output format is not applicable for RS-485.



### 6.4.2 User gain / offset

The user gain and offset configuration of the D-Series device allow individual and application dependent offset and gain settings. For example, an individual gain configuration enables the conversion to other distance units (e.g. m, inch, etc.). The calculation of the user distance with user offset and user gain (Defined by numerator and denominator) is shown below.

$$Distance_{User} = (Distance + Offset_{User}) \frac{GainNum_{User}}{GainDen_{User}}$$

$Distance_{User}$	User distance with offset and gain in 1/10 mm
$Distance$	Measured raw distance of D-Series device in 1/10 mm
$Offset_{User}$	User offset (+/-) in 1/10 mm
$GainNum_{User}$	User gain numerator
$GainDen_{User}$	User gain denominator in 1/10 mm

The commands to configure the user offset and user gain are described in 8.4.2 Set/Get user distance offset (sNuof) and 8.4.3 Set/Get user distance gain (sNuga).

### 6.4.3 Output filter (Distance / error)

The D-Series laser sensor has a configurable output filter for the measurement values (Distance and error codes). There are different filter types available to allow a lot of filter possibilities. Please note that the filters only work and make sense for continuous distance measurement e.g. 8.2.3 Single sensor tracking (sNh) and others.

The output filter is available on the following measuring characteristics (for more details about the measuring characteristics, see 6.3 Measuring characteristic):

- Normal
- Fast
- Precise
- Timed

The output value filter is based on a moving average filter and supports in addition a spike suppression filter and error suppression filter. The filter functionality are described in the table below. The configuration command of the supported filter types are described in 8.3.13 Set/Get measurement filter configuration (sNfi).

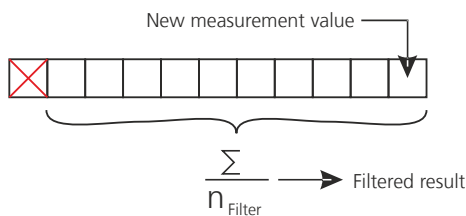

#### Moving average filter

The moving average filter averages a specified number of measurements. A maximum of 32 measurement values can be averaged (Length of filter is configurable). If a new measurement value is present, this value will be added to the filter values, while the latest value will be removed. The sum of all measurement values divided by the size of the filter is the filtered measurement value and transmitted to all outputs.

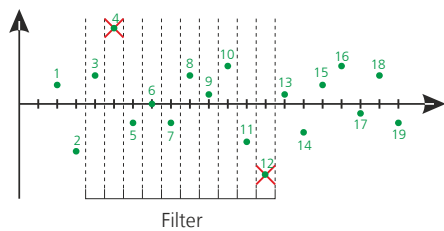

#### Spike suppression filter

The spike suppression filter eliminates pairs of minimum and maximum values inside the filter values (Number of eliminated minimum / maximum pairs is configurable). Always the lowest and highest values are removed from the average filter calculation.

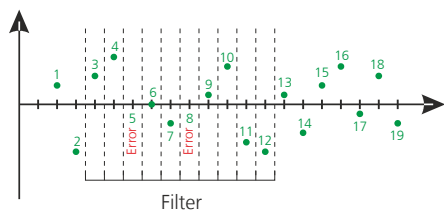

#### Error suppression filter

A maximum number of errors inside the average filter values can be suppressed (Number of suppressed errors is configurable). If the number of errors inside the average filter values is smaller than the specified number of error suppression, no error is shown at the output.

### 6.4.4 Moving Target filter

The D-Series laser sensor has a specific Moving Target filter optimized for measuring on a continuous moving target. In such applications typically no distance jumps occur.



This filter is automatically switched on for Moving Target measurement characteristic configurations. Consider no other filter can be used simultaneously (compare chapter 6.4.3 Output filter (Distance / error) for other filter options).

### 6.4.5 Additional filter functionality

The D-Series laser distance sensors provide some additional measurement filter configurations. These configurations can be used at the same time than the output filter (see chapter 6.4.3) or the Moving Target filter (see chapter 6.4.4) unless otherwise stated. The corresponding command can be found in chapter 8.4.5 Set/Get additional measurement filter configuration (sNafi).

The configuration possibilities allow special functionalities e.g. for positioning applications in the logistics. For more details about the available additional filter configurations, see the table below.

No.	Description measurement filter configurations:	Configuration example
1	Distance jump detection (plausibility check of measured distance). 0 → Filter disabled, >0 → Max. allowed distance change in [0.1 mm]  Every new measured distance will be automatic checked against max. configured allowed distance jump / change. This feature is only available for tracking measurement. See also the corresponding Application Note <a href="#">AN2007</a> on the Dimetix website.	sNafi+1+5000 Max. allowed distance jump / change: ±500 mm.
2	Additional calming filter for distance measurements in Moving Target configuration. This filter smooths distance readings needed in some applications. 0 → Filter disabled, 1...400 → Calming filter length  High filter lengths results in more distance calming / smoothing. Note that the response time of the sensor decreases accordingly when using long filter lengths. It's recommended to start with low filter lengths. See also the corresponding Application Note <a href="#">AN2011</a> on the Dimetix website.	sNafi+2+100 Calming filter length of 100.
3	Additional plausibility check of the signal measurement data (signal monitoring). The max. allowed signal change / jump can be configured in %. 0 → Filter disabled, >0 → Max. allowed signal change in [%]  Signal change check between the last and newest measurement is done according above configuration. See also the corresponding Application Note <a href="#">AN2008</a> on the Dimetix website.	sNafi+3+30 Max. allowed signal change against last valid signals +/-30%.  Remark: Linear signal output configuration via sNum+5 command.
4..n	Not used.	

## 6.5 Digital output

The digital outputs of the D-Series laser distance sensors allows a wide range of configurations to be flexible for many applications. The following configurations are available for the digital output 1 and 2 independently:

- Data source: Distance (Default), speed, signal or temperature
- Switching function: Hysteresis (Default) or pulse
- Pulse width: Only for pulse function

In figure 26 the configuration possibilities with the corresponding commands are shown for both digital outputs. The descriptions of the commands can be found in chapter 8.4.6 Set/Get additional digital output configuration (sNado) and 8.3.7 Set/Get digital output hysteresis (sN1, sN2).

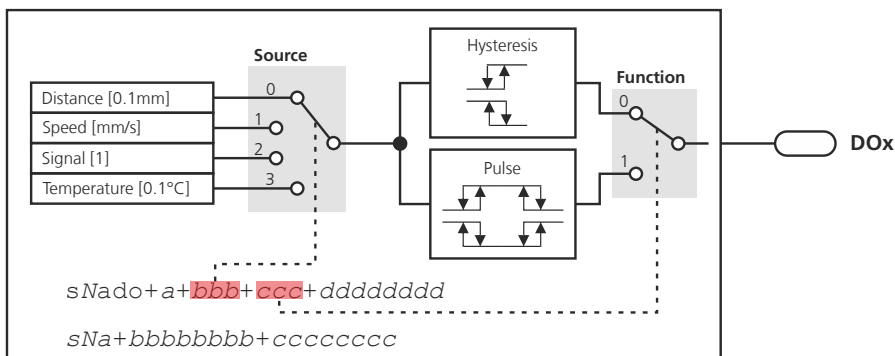

Figure 26: Configuration possibilities of the digital output 1 and 2 (Data source and switching function). Remark: Configuration independently for digital output 1 and 2.

Note, the digital output type can also be configured if needed. However, this always applies to all outputs. For more details see chapter 5.4 Digital output and 8.3.6 Set/Get digital output type (sNot) for the corresponding configuration command.

### 6.5.1 Switching functions

There is a hysteresis and a pulse switching function available. Both of them can be configured with two polarities also shown in figure 26. The polarity will be selected by the values of the ON and OFF level of the first hysteresis. A total of four different configurations are thus possible. See the following four point 1) to 4).

#### 1) Hysteresis: ON level > OFF level

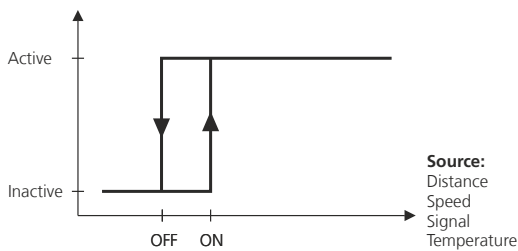

This description and figure is valid for hysteresis configuration and if the configured ON level of the hysteresis is greater than the OFF level.

#### Switching behavior of the shown hysteresis:

With a rising value (x-axis), the digital output is switched active as soon as the value exceeds the ON level. With a falling value, the digital output is switched inactive as soon as the value falls below the OFF level again.

#### 2) Hysteresis: ON level < OFF level

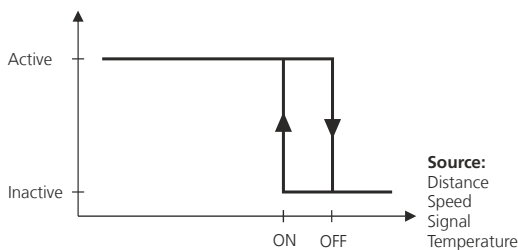

This description and figure is valid for hysteresis configuration and if the configured OFF level of the hysteresis is greater than the ON level.

#### Switching behavior of the shown hysteresis:

With a rising value (x-axis), the digital output is switched inactive as soon as the value exceeds the OFF level. With a falling value, the digital output is switched active as soon as the value falls below the ON level again.

#### 3) Pulse: ON level > OFF level

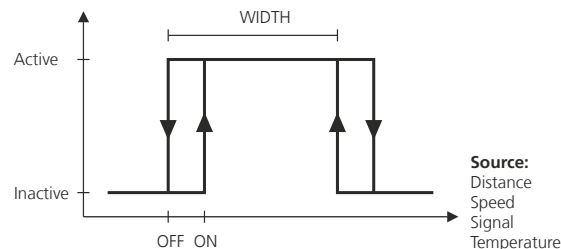

This description and figure is valid for pulse configuration and if the configured ON level of the first hysteresis is greater than the OFF level.

#### Switching behavior of the shown pulse:

With a rising value (x-axis), the digital output is switched active as soon as the value exceeds the ON level, but only until the value also exceeds the ON + WIDTH level. With a falling value, the digital output is switched active as soon as the value falls below the OFF + WIDTH level, but only until the value also falls below the OFF level.

#### 4) Pulse: OFF level > ON level

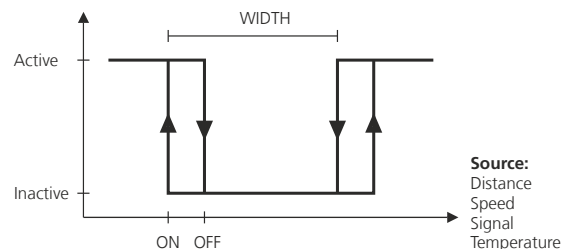

This description and figure is valid for pulse configuration and if the configured OFF level of the first hysteresis is greater than the ON level.

#### Switching behavior of the shown pulse:

With a rising value (x-axis), the digital output is switched inactive as soon as the value exceeds the OFF level, but only until the value also exceeds the OFF + WIDTH level. With a falling value, the digital output is switched inactive as soon as the value falls below the ON + WIDTH level, but only until the value also falls below the ON level.

### 6.5.2 Example

In this example the digital output 2 (DO2) will be configured to supervise the moving speed of the sensor or accordingly of the measuring target. In case of a detected speed greater than  $\pm 500$  mm/s ( $\pm 0.5$  m/s), the digital output 2 must indicate this by switching to the active state.



The digital output 2 switch to active state if the detected speed rise above  $\pm 500$  mm/s. This behavior can be configured by using the pulse function of the digital output. The pulse is defined over the first hysteresis with ON and OFF level and the pulse WIDTH. This three parameters (numbers marked in red) defines the pulse function used for the behavior in this example.

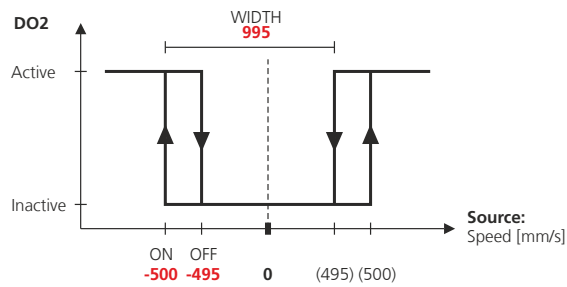

**Used commands for this example:**

1. Set additional digital output configuration:  
(Number: 2, Source: Speed, Function: Pulse, Pulse width: 995)  
s/Nado+2+1+1+995
2. Set digital output hysteresis:  
(Number: 2, ON level: -500, OFF level: -495)  
s/N2-500-495

### 6.6 Factory settings

The following table shows the Dimetix default sensor configuration (factory settings). These configurations are set in a new sensor or after a successful reset. To reset the device to the factory default, see the reset process described in 5.2 Reset push button on page 16.

Configuration parameter	Factory default
Digital input 1 (DO1/DI1)	Inactive
Digital output type (DO1, DO2, DOE)	NPN output type
Digital output 1 hysteresis (DO1/DI1)	ON level: 2005 mm OFF level: 1995 mm
Digital output 2 hysteresis (DO2)	ON level: 995 mm OFF level: 1005 mm
Digital output data source and function (DO1 / DO2)	Data source: 0 (Distance, unit for hysteresis levels in [0.1mm]) Function: 0 (Hysteresis)
Analog output	4...20 mA for 0...10 m distance 0 mA in error case
Sensor ID	0
Serial communication settings (RS-232, RS-422 / RS-485)	7 (19'200 Baud, 7 data bits, parity even, 1 stop bit)
RS-422 / RS-485	RS-422 / RS-485 active
SSI interface	SSI Inactive Data coding: Binary Data format: 24-Bit No error state and error code added Error value: 0
Sensor behavior – Operation mode	Controlled mode (Auto start and user mode inactive) User mode inactive
Sensor behavior – Measurement characteristic	0 (Normal)
Sensor behavior – Data output	Gain: 1 Offset: 0 mm Format: 0 (Default commands answers, no display output format) Filter: Inactive Additional filter: All inactive

## 7 Operation

### 7.1 Measurement overview

The D-Series laser sensors supports different measurement possibilities to cover high variety of applications. The table below shows the available distance measurement commands and some basic commands. The distance measurement commands are separated in two groups. The "Distance measurement" group commands can be used for one or more sensors on a single line (e.g. multiple sensors on the RS-422 interface). The other command group "Single distance measurement" is only for one sensor on a single line. Otherwise there could be communication problems.

Group	Measurement possibilities	Commands
Basic measurement (one or more sensors on a single line)	Clear sensor / Stop measurement	8.2.1 Stop / Clear command (sNc)
	Laser on (Pointing for sensor adjustment)	8.2.10 Laser on (sNo)
	Signal measurement (Single tracking possible)	8.2.7 Signal measurement (sNm)
	Temperature measurement	8.2.8 Temperature measurement (sNt)
	Read / Clear error stack	8.2.9 Read/Clear error stack (sNre, sNce)
Distance measurement (one or more sensors on a single line)	Distance measurement	8.2.2 Distance measurement (sNg)
	Tracking distance measurement with buffering	8.2.5 Tracking with buffering – Start (sNf)
		8.2.6 Read out – Tracking with buffering (sNq)
Single distance measurement ( <b>only</b> one sensor on a single line)	Single tracking distance measurement	8.2.3 Single sensor tracking (sNh)
	Single tracking distance measurement with timer	8.2.4 Single sensor tracking with timer (sNh)

### 7.2 Installation

#### 7.2.1 Connection of the device

The connection of the D-Series laser sensor is done with two screw terminal plugs. It's essential to do the connections of the device according the following sequence:

- 1) Check if power supply is off and used interfaces do not already transmit data
- 2) Wiring of the screw terminal plugs with used ports (Power supply and used device interface)
- 3) Connect the screw terminal plugs (First the screw terminal plug with power supply)
- 4) Assemble the exchangeable cover and the D-Series laser sensor carefully.
  - Before tighten the exchangeable cover: Check that the cover is properly aligned with the housing of the D-Series device. Make sure the four centering bolts are in position before tighten the screws.
  - Tighten the four screws over cross to have an equally pressure on the gasket. The target torque for these screws (Philips Slotted Combo, Philips size 1, slot size 2) is 1.6 Ncm.
- 5) Switch on the power supply
- 6) The device is read for operation

**Connect the screw terminal plugs under voltage or while some interfaces are already transmitting data can damage the device.**

#### NOTICE

- Make sure that the sensors power supply and also the power supplies off all other devices connected to the sensor are switched off when connection the screw terminals.
- No warranty will be granted on improper handling.

**If the exchangeable cover or the cable gland is not assembled properly IP65 protection is not reached and the device can be damaged by entering water.**

#### NOTICE

- Check if cover closes properly and that screws are turned tight. Use a target torque of 1.6 Ncm.
- Check if cable gland closes tight around the cable.

#### 7.2.2 Mounting of the device

Four slotted holes for M4 (or M3) screws and four additional threaded holes with hexagon socket set screws on the sensor side make it easy to mount the D-Series sensors.



Generally for outdoor applications it's recommend to use a protection against water, rain, snow, pollution, direct sunlight, etc. Since the D-Series sensor is an optical measuring system with lenses, the sensor optics must always be clean to ensure reliable distance measurements. Install a roof or a housing to protect the sensors. See also our accessories on [www.dimetix.com](http://www.dimetix.com) for an example housing (air cooling housing).

Always follow all applicable safety regulations and never use the device outside the specifications stated under 4 Technical data on page 12.

### NOTICE

**When D-Series laser sensors are mounted with the exchangeable cover facing upwards drooping water could enter through the valve diaphragm and damage the device.**

- Cover the sensor to prevent water from dropping on the valve diaphragm.

### 7.2.3 Mounting of reflective plate

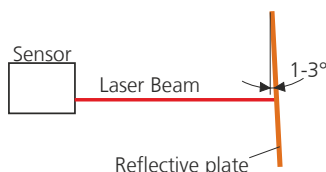

Figure 27: Mounting of reflective plates

Measuring to the reflective plate may generate erroneous measurements, if the reflective plate is mounted exactly at an angle of  $90^\circ$  to the laser beam. Therefore mount the reflective plate like shown in figure 27. This prevents the device from too high reflections direct to the receiver lens or laser output.

Avoid direct sunlight on the reflective plate to increase measurement performance.



The measuring range (min. / max. distance) on the reflective plate depends on the D-Series device type. Please check the device specifications in chapter 4.1 for detailed information.

### 7.2.4 Alignment of the laser beam

The D-Series sensor provides four hexagon socket set screw for easy sensor alignment. For more details see chapter 3.2.

But alignment of the laser beam is often difficult when the target is far away. As a hint: As a coarse alignment at a nearer target distance may helps for such difficulties. For additional accessories, see the Dimetix website [www.dimetix.com](http://www.dimetix.com).

For applications with two or more sensors measuring in the same or opposite direction ensure enough clearance between the laser spots. The laser must not point to another laser sensor directly.

### NOTICE

**Never point with a laser sensor direct to the optics of another laser sensor. This may damage the sensor.**

- No warranty will be granted on improper handling.

## 7.3 Measuring performance influence

The D-Series devices are optical instruments, whose operation is influenced by environmental conditions. Therefore the measuring range and speed achieved in a specific application may vary. The following conditions can influence the measuring range and speed in a positive or negative manner:

Keywords	Factors increasing range / speed	Factors reducing range / speed
Target surface	Bright, matt and flat natural surfaces. Optimal natural surfaces: white, matt and flat Reflective surfaces such as the Dimetix orange target plates (see accessories on <a href="http://www.dimetix.com">www.dimetix.com</a> )	Rough and dark surfaces
Airborne particles	Clean air	Dust, fog, heavy rainfall, heavy snowfall
Sunlight	Darkness, no sunlight	Bright sunlight on the target

The measurement range may also be influenced by the configuration of the measurement characteristic. See the descriptions of the measuring characteristics in 6.3 Measuring characteristic on page 30.

The D-Series laser sensor does not compensate the influence of the atmospheric environment, which may be relevant when measuring long distances (e.g. > 150 m). These effects are described in H. Kahmen & W. Faig: "Surveying", (1988).



## 7.4 Prevention of erroneous measurements

This chapter should help to prevent erroneous measurement with the D-Series sensors. Please consider the following notes in the corresponding applications. There are further information on the knowledge base on the Dimetix website ([www.dimetix.com](http://www.dimetix.com)).

### 7.4.1 Rough surfaces

On a rough surface (e.g. coarse plaster) measure against the center of the illuminated area. To avoid measuring to the bottom of gaps in the surface use a target plate or board (see accessories on [www.dimetix.com](http://www.dimetix.com)).

### 7.4.2 Transparent surfaces

To avoid measuring errors, do not measure against transparent surfaces such as colorless liquids (such as water) or (dust-free) glass. In case of unfamiliar materials and liquids, always carry out a trial measurement.



Erroneous measurements can occur when aiming through glass panes or if there are several objects in the line of sight.

### 7.4.3 Wet, smooth or high-gloss surfaces

- Aiming at an "acute" angle deflects the laser beam. The D-Series device may receive a signal that is too weak (error message 255) or it may measure the distance targeted by the deflected laser beam.
- If aiming at a right angle, the D-Series device may receive a signal that is too strong (error message 256).

#### NOTICE

**Do not measure on high-gloss surfaces e.g. mirrors or other high reflective material. This may damage the sensor.**

- No warranty will be granted on improper handling.

### 7.4.4 Inclined, round surfaces

Measurement is possible as long as there is enough target surface area for the laser spot. On irregular and round surfaces the arithmetic average of the illuminated surfaces will be measured.

### 7.4.5 Multiple reflections

#### NOTICE

**Erroneous measurements may occur if the laser beam is reflected by other objects than the target.**

- Avoid any reflective object along the measurement path.

### 7.4.6 Influence of other laser beams, sun light and others

#### NOTICE

**Sunlight, flashlights or similar may disturb the distance measurement**

- Shading the sensor from the top and the sides can help to reduce these disturbances.

#### NOTICE

**Aiming directly to the sun or the sun is exactly behind the target may disturb the distance measurement or damage the D-Series laser sensor.**

#### NOTICE

**Air flickers may disturb the distance measurement.**



**NOTICE**

**Laser beams of other sensors or devices may disturb the distance measurement or damage the D-Series laser sensor.**

- Other laser beams must be aligned with enough clearance to the D-Series sensor optic.
- No warranty will be granted on improper handling.

## 7.5 Laser life time consideration

Since the life time of the laser is limited, operate the device in a way, that the laser is switched on only when necessary. The laser life time stated under 4.1 Specifications on page 12 relates to the time while the laser is on.

The following conditions affects the laser life time in a positive manner:

- Low ambient temperature (high temperatures reduce laser life time)
- Switch laser off if possible (only do continuous measurements if necessary)

## 7.6 Heating functionality

This chapter is only relevant for devices with heating option used to extend the min. temperature range. To enable proper functionality with such devices the following points have to be considered:

- Consider the required supply current, see the specifications in 4.1
- The sensor heating procedure takes some heating time before distance measurements are possible. The heating time depends on operating temperature (e.g.  $T_{\text{Operating}}: -40^{\circ}\text{C} \rightarrow$  Heating time: ~2...4 min).
- For application with continuous attached power supply (D-Series device powered, green power LED on) the heating procedure is running automatically. There is no heating time to wait before distance measurement is possible.

## 7.7 Application Notes / Examples

For various Application Examples and also Application Note, see the Dimetix website [www.dimetix.com](http://www.dimetix.com). There are several notes on the usage of the sensor interfaces and some example how to use the sensor in a specific application.



## 8 Command set

### 8.1 General

#### 8.1.1 Command termination

Every command for the D-Series devices are ASCII based and terminated with <CrLf><sup>1</sup> at the end of every command. The D-Series devices command answers are terminated in the same manner (<CrLf>).

#### 8.1.2 Device identification *N*

The D-Series device can be addressed with a configurable device ID. This ID is represented in the commands by the placeholder *N*. At the location of *N* insert the Device ID.

#### 8.1.3 Parameter separator

The command syntax uses the '+' sign as parameter separator. The '+' sign can be replaced by the minus '-' sign if applicable by the command.

#### 8.1.4 Set/Get commands

All configuration commands of the D-Series device are used to set new configuration values. The same command without a configuration value can also be used to read the set value. The corresponding command syntax is described with an example command (*sNeg*) below:

	<b>Set command</b>	<b>Get command</b>
Command	<i>sNeg+aaaaaaaa&lt;CrLf&gt;</i>	<i>sNeg&lt;CrLf&gt;</i>
Return successful	<i>gNeg?&lt;CrLf&gt;</i>	<i>gNeg+aaaaaaaa&lt;CrLf&gt;</i>
Return error	<i>gN@Ezzz&lt;CrLf&gt;</i>	<i>gN@Ezzz&lt;CrLf&gt;</i>
Parameters	<i>N</i> Device ID <i>aaaaaaaa</i> Command parameter / configuration value; + positive / - negative <i>zzz</i> Error code	

As an example for a device with the ID of 3 (Device ID → 3) the command above looks like the following: *s3eg+100<CrLf>* where '3' is the device ID and '+100' the command parameter.

#### 8.1.5 Startup sequence

After power-on, the D-Series device does the initialization and afterward a startup string *gN?* over the serial interfaces. As described before, *N* is the placeholder for the device ID of the connected D-Series sensor. After sending this startup string, the D-Series device is ready to use.

## 8.2 Operation commands

### 8.2.1 Stop / Clear command (*sNc*)

Stops the current execution and resets the status LEDs as well as the digital outputs.

	<b>Command</b>	
Command	<i>sNc&lt;CrLf&gt;</i>	
Return successful	<i>gN?&lt;CrLf&gt;</i>	
Return error	<i>gN@Ezzz&lt;CrLf&gt;</i>	
Parameters	<i>N</i> Device ID <i>zzz</i> Error code	

### 8.2.2 Distance measurement (*sNg*)

Triggers simple measurement of distance. Each new command cancels an active measurement.

<sup>1</sup> <CrLf>: Cr → Carriage return, Lf → Line feed



	<b>Command</b>	
Command	sNg<CrLf>	
Return successful	gNg+aaaaaaaa<CrLf>	
Return error	gN@Ezzz<CrLf>	
Parameters	N	Device ID
	aaaaaaaa	Distance in 1/10 mm
	zzz	Error code

### 8.2.3 Single sensor tracking (sNh)

Triggers continuous measurements of the distance. The measurements are made as fast as possible (Measurement speed depends on target conditions). The measurements are continued until the Stop / Clear command (sNc) is issued. The status LEDs and the digital outputs are updated corresponding to the new measured distance. Due to the continuous measurement output the following notes / cautions have to be considered on a RS-422 / RS-485 line:



Do not use this command on a RS-485 line. On RS-485 it is only possible to stop continuous measurement with a power off/on cycle.



For more than one device on a RS-422 line first stop tracking before communicating with an other device.

	<b>Command</b>	
Command	sNh<CrLf>	
Return successful	gNh+aaaaaaaa<CrLf>	
Return error	gN@Ezzz<CrLf>	
Parameters	N	Device ID
	aaaaaaaa	Distance in 0.1 mm
	zzz	Error code

### 8.2.4 Single sensor tracking with timer (sNh)

This command does the same as the sNn command but with the possibility to set a desired sampling time / timer. The timer triggers continuous measurements in the set interval time. For Moving Target characteristic only sample time 0 is allowed. The measurements are continued until the Stop / Clear command (sNc) is issued. Due to the continuous measurement output the following notes / cautions have to be considered on a RS-422 / RS-485 line:



Do not use this command on a RS-485 line. On RS-485 it is only possible to stop continuous measurement with a power off/on cycle.



For more than one device on a RS-422 line first stop tracking before communicating with an other device.



	<b>Command</b>	
Command	<code>sNh+aaaaaaaa&lt;CrLf&gt;</code>	
Return successful	<code>gNh+bbbbbbbb&lt;CrLf&gt;</code>	
Return error	<code>gN@Ezzz&lt;CrLf&gt;</code>	
Parameters	<i>N</i>	Device ID
	<i>aaaaaaaa</i>	Sampling time in 1 ms (Range: 0...86'400'000 ms, 0 → max possible rate)
	<i>bbbbbbbb</i>	Distance in 0.1 mm
	<i>zzz</i>	Error code

### 8.2.5 Tracking with buffering – Start (sNf)

Triggers continuous measurements of the distance with internal buffering in the device (buffer for one measurement). The rate of measurements is defined with the sampling time. If the sampling time is set to zero, the measurements are executed as fast as possible (Measuring speed depends on target conditions). For Moving Target characteristic only sample time 0 is allowed. The latest measurement can be read out from the D-Series sensor with the command `sNq`. The measurements are continued until the `sNc` command is issued.

	<b>Set command</b>	<b>Get command</b>
Command	<code>sNf+aaaaaaaa&lt;CrLf&gt;</code>	<code>sNf&lt;CrLf&gt;</code>
Return successful	<code>gNf?&lt;CrLf&gt;</code>	<code>gNf+aaaaaaaa&lt;CrLf&gt;</code>
Return error	<code>gN@Ezzz&lt;CrLf&gt;</code>	<code>gN@Ezzz&lt;CrLf&gt;</code>
Parameters	<i>N</i>	Device ID
	<i>aaaaaaaa</i>	Sampling time in 1 ms (Range: 0...86'400'000 ms, 0 → max possible rate)
	<i>zzz</i>	Error code

### 8.2.6 Read out – Tracking with buffering (sNq)

After starting "tracking with buffering" with the command `sNf`, the latest measurement can be read out from the sensor with the command `sNq`. This command does not work if the tracking with buffering is not started.

	<b>Command</b>	
Command	<code>sNq&lt;CrLf&gt;</code>	
Return successful	<code>gNq+aaaaaaaa+b&lt;CrLf&gt;</code>	
Return error	<code>gN@Ezzz+b&lt;CrLf&gt;</code>	
Parameters	<i>N</i>	Device ID
	<i>aaaaaaaa</i>	Distance in 0.1 mm
	<i>b</i>	0 → No new measurement since last <code>sNq</code> command 1 → One new measurement since last <code>sNq</code> command, not overwritten 2 → More than one measurement since last <code>sNq</code> command, overwritten
	<i>zzz</i>	Error code

### 8.2.7 Signal measurement (sNm)

Signal measurement can be done continuously or with a single measurement. The signal strength is returned as a relative number in the typical range of 0 to ~25'000. The value for the signal strength is just an approximate value, it differs from device to device, device series and also depends on environment conditions. The repetitive signal measurements are continued until the Stop / Clear command (`sNc`) is issued. Due to the continuous measurement output possibility the following notes / cautions have to be considered on a RS-422 / RS-485 line:



Do not use the repetitive signal measurement command on a RS-485 line. On RS-485 it is only possible to stop continuous signal measurement with a power off/on cycle.



For more than one device on a RS-422 line first stop repetitive signal measurement before communicating with an other device.

<b>Command</b>									
Command	<code>sNm+a&lt;CrLf&gt;</code>								
Return successful	<code>gNm+bbbbbbbb&lt;CrLf&gt;</code>								
Return error	<code>gN@Ezzz&lt;CrLf&gt;</code>								
Parameters	<table> <tr> <td><i>N</i></td> <td>Device ID</td> </tr> <tr> <td><i>a</i></td> <td>0 → Single measurement 1 → Repetitive measurements (<b>Warning: Consider the listed notes and cautions!</b>)</td> </tr> <tr> <td><i>bbbbbbbb</i></td> <td>Signal strength (range 0.. ~25'000)</td> </tr> <tr> <td><i>zzz</i></td> <td>Error code</td> </tr> </table>	<i>N</i>	Device ID	<i>a</i>	0 → Single measurement 1 → Repetitive measurements ( <b>Warning: Consider the listed notes and cautions!</b> )	<i>bbbbbbbb</i>	Signal strength (range 0.. ~25'000)	<i>zzz</i>	Error code
<i>N</i>	Device ID								
<i>a</i>	0 → Single measurement 1 → Repetitive measurements ( <b>Warning: Consider the listed notes and cautions!</b> )								
<i>bbbbbbbb</i>	Signal strength (range 0.. ~25'000)								
<i>zzz</i>	Error code								

### 8.2.8 Temperature measurement (sMt)

Triggers measurement of the temperature of the device.

<b>Command</b>							
Command	<code>sMt&lt;CrLf&gt;</code>						
Return successful	<code>gMt+aaaaaaaa&lt;CrLf&gt;</code>						
Return error	<code>gN@Ezzz&lt;CrLf&gt;</code>						
Parameters	<table> <tr> <td><i>N</i></td> <td>Device ID</td> </tr> <tr> <td><i>aaaaaaaa</i></td> <td>Temperature in 0.1°C</td> </tr> <tr> <td><i>zzz</i></td> <td>Error code</td> </tr> </table>	<i>N</i>	Device ID	<i>aaaaaaaa</i>	Temperature in 0.1°C	<i>zzz</i>	Error code
<i>N</i>	Device ID						
<i>aaaaaaaa</i>	Temperature in 0.1°C						
<i>zzz</i>	Error code						

### 8.2.9 Read/Clear error stack (sNre, sNce)

Reads or clears the error stack of the device. The errors in the error stack are stored permanently until a clear error stack command (sNce) is done.

	<b>Read command</b>	<b>Clear command</b>						
Command	<code>sNre&lt;CrLf&gt;</code>	<code>sNce&lt;CrLf&gt;</code>						
Return successful	<code>gNre+aaa+aaa+aaa+...&lt;CrLf&gt;</code>	<code>gNce?&lt;CrLf&gt;</code>						
Return error	<code>gN@Ezzz&lt;CrLf&gt;</code>	<code>gN@Ezzz&lt;CrLf&gt;</code>						
Parameters	<table> <tr> <td><i>N</i></td> <td>Device ID</td> </tr> <tr> <td><i>aaa</i></td> <td>List of occurred error codes (stored since last error stack clear command sNce) First list entry is the last occurred error code, 0 → No error).</td> </tr> <tr> <td><i>zzz</i></td> <td>Error code</td> </tr> </table>		<i>N</i>	Device ID	<i>aaa</i>	List of occurred error codes (stored since last error stack clear command sNce) First list entry is the last occurred error code, 0 → No error).	<i>zzz</i>	Error code
<i>N</i>	Device ID							
<i>aaa</i>	List of occurred error codes (stored since last error stack clear command sNce) First list entry is the last occurred error code, 0 → No error).							
<i>zzz</i>	Error code							

### 8.2.10 Laser on (sNo)

Switches the laser beam on for easy sensor adjustment. The laser is on until the Stop / Clear command (sNc) is issued.

<b>Command</b>					
Command	<code>sNo&lt;CrLf&gt;</code>				
Return successful	<code>gN?&lt;CrLf&gt;</code>				
Return error	<code>gN@Ezzz&lt;CrLf&gt;</code>				
Parameters	<table> <tr> <td><i>N</i></td> <td>Device ID</td> </tr> <tr> <td><i>zzz</i></td> <td>Error code</td> </tr> </table>	<i>N</i>	Device ID	<i>zzz</i>	Error code
<i>N</i>	Device ID				
<i>zzz</i>	Error code				

## 8.3 Configuration commands

Generally the configuration commands are volatile until the configurations of the device are saved with the 8.3.16 Save configuration parameters (sNs) command. There exist some exceptions where the configurations will be saved automatically but these are explicitly mentioned.



For details about the configuration process and the possible configuration types see chapter 6.1.



Use the Save configuration parameters (sNs) command to save device configurations permanently.

### 8.3.1 Set communication settings (sNbr)

Sets the communication settings for the serial interface RS-232 / RS-422 / RS-485. The settings number 7 (marked with gray) is the default communication setting (factory default or after a device reset).



A change in the communication setting number will be activated after power off sequence.

<b>Command</b>																																				
Command	sNbr+aa<CrLf>																																			
Return successful	gN?<CrLf>																																			
Return error	gN@Ezzz<CrLf>																																			
Parameters	<p><i>N</i> Device ID</p> <p><i>aa</i> Number of communication setting:</p> <table border="1" data-bbox="667 981 1264 1191"> <thead> <tr> <th>aa</th> <th>Baud rate (bps)</th> <th>Data bits</th> <th>Parity</th> <th>Stop bits</th> </tr> </thead> <tbody> <tr> <td>1</td> <td>9600</td> <td>8</td> <td>None</td> <td>1</td> </tr> <tr> <td>2</td> <td>19200</td> <td>8</td> <td>None</td> <td>1</td> </tr> <tr> <td>6</td> <td>9600</td> <td>7</td> <td>Even</td> <td>1</td> </tr> <tr> <td>7</td> <td>19200</td> <td>7</td> <td>Even</td> <td>1</td> </tr> <tr> <td>10</td> <td>115200</td> <td>8</td> <td>None</td> <td>1</td> </tr> <tr> <td>11</td> <td>115200</td> <td>7</td> <td>Even</td> <td>1</td> </tr> </tbody> </table> <p><i>zzz</i> Error code</p>	aa	Baud rate (bps)	Data bits	Parity	Stop bits	1	9600	8	None	1	2	19200	8	None	1	6	9600	7	Even	1	7	19200	7	Even	1	10	115200	8	None	1	11	115200	7	Even	1
aa	Baud rate (bps)	Data bits	Parity	Stop bits																																
1	9600	8	None	1																																
2	19200	8	None	1																																
6	9600	7	Even	1																																
7	19200	7	Even	1																																
10	115200	8	None	1																																
11	115200	7	Even	1																																

### 8.3.2 Set device ID (sNid)

Sets the device identification *N*. The device ID *N* is used for the most of all commands.

<b>Command</b>	
Command	sNid+aa<CrLf>
Return successful	gN?<CrLf>
Return error	gN@Ezzz<CrLf>
Parameters	<p><i>N</i> Device ID</p> <p><i>aa</i> New device ID, range 0...99</p> <p><i>zzz</i> Error code</p>

### 8.3.3 Set/Get analog output min level (sNvm)

This command sets the minimum analog output current level (0 or 4 mA).

	<b>Set command</b>	<b>Get command</b>
Command	sNvm+a<CrLf>	sNvm<CrLf>
Return successful	gNvm?<CrLf>	gNvm+a<CrLf>
Return error	gN@Ezzz<CrLf>	gN@Ezzz<CrLf>
Parameters	<p><i>N</i> Device ID</p> <p><i>a</i> Minimum current for analog output 0 → Minimum current is 0 mA 1 → Minimum current is 4 mA</p> <p><i>zzz</i> Error code</p>	



### 8.3.4 Set/Get analog output value in error case (sNve)

This command sets the analog output current level in mA in case of an error. This level can be lower than the minimum level set with the *sNvm* command.

	<b>Set command</b>	<b>Get command</b>
Command	sNve+aaa<CrLf>	sNve<CrLf>
Return successful	gNve?<CrLf>	gNve+aaa<CrLf>
Return error	gN@Ezzz<CrLf>	gN@Ezzz<CrLf>
Parameters	N aaa zzz	Device ID Value in case of an error in 0.1 mA, range 0...200 If the value is set to 999, in case of an error keep the last valid distance Error code

### 8.3.5 Set/Get analog output distance range (sNv)

Sets the minimum and maximum distances corresponding to the minimum and maximum analog output current levels.

**0...20mA**

$$A_{out} = \frac{DIST - D_{min}}{D_{max} - D_{min}} * 20mA$$

**4...20mA**

$$A_{out} = \frac{DIST - D_{min}}{D_{max} - D_{min}} * 16 mA + 4 mA$$

A<sub>out</sub> → Analog current output

DIST → Actual measured distance

D<sub>min</sub> → Distance programmed for the minimum output current

D<sub>max</sub> → Distance programmed for the maximum output current

	<b>Set command</b>	<b>Get command</b>
Command	sNv+aaaaaaaa+bbbbbbbb<CrLf>	sNv<CrLf>
Return successful	gNv?<CrLf>	gNv+aaaaaaaa+bbbbbbbb<CrLf>
Return error	gN@Ezzz<CrLf>	gN@Ezzz<CrLf>
Parameters	N aaaaaaaa bbbbbbbb zzz	Device ID Minimum distance in 1/10 mm corresponding to 0 mA / 4 mA Maximum distance in 1/10 mm corresponding to 20 mA Error code

### 8.3.6 Set/Get digital output type (sNot)

Sets the output type for all digital outputs. It's possible to select NPN, PNP or Push-Pull outputs.



The configuration of the output type takes effect on all digital outputs (DO1, DO2, DOE).



	<b>Set command</b>	<b>Get command</b>
Command	sNot+a<CrLf>	sNot<CrLf>
Return successful	gNot?<CrLf>	gNot+a?<CrLf>
Return error	gN@Ezzz<CrLf>	gN@Ezzz<CrLf>
Parameters	<i>N</i> Device ID <i>a</i> Digital output type (for all digital outputs): 0 → NPN (Low driven, load between V+ and DOx output) 1 → PNP (High driven, load between DOx output and GND) 2 → Push-pull (Low & High driven) <i>zzz</i> Error code	

### 8.3.7 Set/Get digital output hysteresis (sN1, sN2)

Sets or gets the individual digital output hysteresis of the two digital outputs 1 and 2. For every output a switching ON and OFF level must be configured. For details about the configuration possibilities and its functionality see chapter 6.5.

	<b>Set command</b>	<b>Get command</b>
Command	sNa+bbbbbbb+ccccccc<CrLf>	sNa<CrLf>
Return successful	gNa?<CrLf>	gNa+bbbbbbb+ccccccc<CrLf>
Return error	gN@Ezzz<CrLf>	gN@Ezzz<CrLf>
Parameters	<i>N</i> Device ID <i>a</i> Digital output number (1 or 2) <i>bbbbbbb</i> ON level of the hysteresis (unit depends on data source, [0.1mm], [mm/s], [1] or [0.1°C]) <i>ccccccc</i> OFF level of the hysteresis (unit depends on data source, [0.1mm], [mm/s], [1] or [0.1°C]) <i>zzz</i> Error code	

### 8.3.8 Set/Get digital input function (sNDI1)

The digital output DO1/DI1 of the D-Series sensors can also be used as digital input. The command sNDI1 configures a function / event for the device. The level of the digital input can be read with the command sNRI.



Activation of a digital input function of DI1, deactivate the digital output DO1 automatically.

	<b>Set command</b>	<b>Get command</b>
Command	sNDI1+aaaaaaaa<CrLf>	sNDI1<CrLf>
Return successful	gNDI1?<CrLf>	sNDI1+aaaaaaaa<CrLf>
Return error	gN@Ezzz<CrLf>	gN@Ezzz<CrLf>
Parameters	<i>N</i> Device ID <i>aaaaaaaa</i> Digital input functions: 0 → Digital input DI1 deactivated (Digital output DO1 activated). 2 → Trigger Distance measurement (sNg) 3 → Start/Stop Single sensor tracking (sNh) 4 → Start/Stop Tracking with buffering and time (sNf+) <sup>1</sup> 8 → Start/Stop Single sensor tracking with time (sNh+) <sup>2</sup> <i>zzz</i> Error code	

### 8.3.9 Get digital input (sNRI)

Reads the digital input level (low / high) of DO1/DI1. Note for the use of DO1 instead of DI1, this command reads the logical level of the digital output.

<sup>1</sup> sNf+: Uses the tracking time set by a previous tracking command sNf+aaaaaaaa / sNh+aaaaaaaa (a → Measuring time)

<sup>2</sup> sNh+: Uses the tracking time set by a previous tracking command sNh+aaaaaaaa / sNf+aaaaaaaa (a → Measuring time)



	<b>Command</b>	
Command	sNRI<CrLf>	
Return successful	gNRI+a<CrLf>	
Return error	gN@Ezzz<CrLf>	
Parameters	<i>N</i>	Device ID
	<i>a</i>	0 → Input Off (Signal Low) 1 → Input On (Signal High)
	<i>zzz</i>	Error code

### 8.3.10 Set/Get configuration of RS-422/485 and SSI (sNSSI)

The SSI interface is not available on all D-Series devices (check the device specification for details, see chapter 4.1) and is deactivated by default. The SSI and the RS-422/485 interfaces uses the same differential output driver, so only one of them can be activated at the same time.



Only one interface (RS-422/485 or SSI) can be activated at the same time.

	<b>Set command</b>	<b>Get command</b>
Command	sNSSI+aaa<CrLf>	sNSSI<CrLf>
Return successful	gNSSI?<CrLf>	gNSSI+aaa<CrLf>
Return error	gN@Ezzz<CrLf>	gN@Ezzz<CrLf>
Parameters	<i>N</i>	Device ID
	<i>aaa</i>	Binary coded settings: Bit0 0 → Activate RS-422/485 interface (SSI is deactivated) 1 → Activate SSI interface with settings below (RS-422/485 is deactivated) Bit1 0 → Binary coded (applied for: All data) 1 → Gray coded (applied for: 23/24-Bit data value, attached 8-Bit error data) Bit2 0 → No error bit output 1 → Error bit attached to the output data value Bit3 0 → No additional error data output 1 → Attach 8-Bit error data (Calculation: Error data = Error code <sup>1</sup> - 200) <sup>2</sup> Bit4..5 00 → 24-Bit data value 01 → 23-Bit data value 10 → 25-Bit data value Bit6..15 → Not used
	<i>zzz</i>	Error code

#### Configuration example: SSI activated, 23-Bit data (binary), 8-Bit error data (binary) and error bit

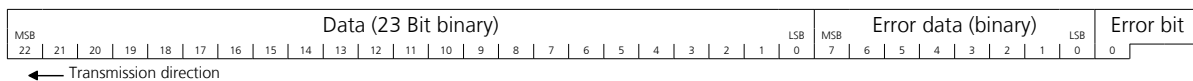

Configuration:	Binary data: 11101 <sub>2</sub> → 29 Bit0 → 1: SSI interface activated Bit1 → 0: Binary coded data output Bit2 → 1: Error bit attached to the output data value Bit3 → 1: Attach 8-Bit SSI error data (Error code - 200) Bit4 → 1: 23-Bit data value
Command:	sNSSI+29

<sup>1</sup> Possible error codes of sensor, see table in chapter 8.6 Error codes.

<sup>2</sup> Adaptation of sensor error code range for SSI transmission within 8-Bit. E.g.: @E255 (Low signal) - 200 = 55 (SSI error data for SSI transmission)



### 8.3.11 Set/Get error value of SSI output (sNSSIe)

In case of an error the SSI output will show a value corresponding to this configuration. There can be a replacement value in a range of 0 to 16777215 (24-Bit) or 0 to 8388607 (23-Bit), the last valid distance value or the error code. All values are shown either as binary value or gray coded depending on SSI configuration.

	<b>Set command</b>	<b>Get command</b>
Command	sNSSIe+aaaaaaaa<CrLf>	sNSSIe<CrLf>
Return successful	gNSSIe?<CrLf>	gNSSIe+aaaaaaaa<CrLf>
Return error	gN@Ezzz<CrLf>	gN@Ezzz<CrLf>
Parameters	<i>N</i> Device ID <i>aaaaaaaa</i> 0..2 <sup>24</sup> -1 / 0..2 <sup>23</sup> -1 → Replacement value (depending on the SSI settings, the value will be converted to gray code). In case of an error, the data value will be replaced by this replacement value. -1 → In case of an error the last distance value will stay at the output. -2 → In case of an error, the error code will be at the output. <i>zzz</i> Error code	

### 8.3.12 Set/Get measuring characteristic (sNmc)

The D-Series device provides different measuring characteristics to allow an adjustment of the measuring process of the device. This functionality makes it possible to optimize measuring accuracy and measuring speed for a specific application and its requirement. For detailed information about the available measuring characteristics, see 6.3 Measuring characteristic.

	<b>Set command</b>	<b>Get command</b>
Command	sNmc+aaaaaaaa<CrLf>	sNmc<CrLf>
Return successful	gNmc?<CrLf>	gNmc+aaaaaaaa<CrLf>
Return error	gN@Ezzz<CrLf>	gN@Ezzz<CrLf>
Parameters	<i>N</i> Device ID <i>aaaaaaaa</i> 0 → Normal 1 → Fast 2 → Precise 3 → Timed 4 → Moving target <i>zzz</i> Error code	

### 8.3.13 Set/Get measurement filter configuration (sNfi)

The filter applied to the distance measurement values can be configured with the following parameters and guidelines.

	<b>Set command</b>	<b>Get command</b>
Command	sNfi+aa+bb+cc<CrLf>	sNfi<CrLf>
Return successful	gNfi?<CrLf>	gNfi+aa+bb+cc<CrLf>
Return error	gN@Ezzz<CrLf>	gN@Ezzz<CrLf>
Parameters	<i>N</i> Device ID <i>aa</i> Filter length (0 → Filter off, 2...32 → Allowed filter length) <i>bb</i> Number of spikes to suppress (always pairs of min and max value) <i>cc</i> Maximum number of errors to suppress. Condition: 2*bb + cc ≤ 0.4*aa <i>zzz</i> Error code	

### 8.3.14 Set/Get auto start configuration (sNA)

This command activates the stand-alone mode with auto start of the D-Series devices. It triggers continuous measurements of the distance. The analog, digital and SSI outputs are updated according to the measured distance values. The sampling time defines the measurement rate. If the sampling time is set to zero, the measurements are executed as fast as possible (depending on target conditions). For Moving Target characteristic only sample time 0 is allowed. The stand-alone mode with auto start is active until the Stop / Clear command (sNc) is received by the device. The Stop / Clear command only suspends the stand-alone mode with auto start temporarily. To deactivate this mode permanently a Save configuration (sNs) command after the Stop / Clear command is necessary.



The stand-alone mode with auto start is stored permanently in the device and activated immediately. This mode is activated automatically after power on.



To stop / clear the stand-alone mode with auto start permanently a Save configuration (*sNs*) command after the Stop / Clear command is necessary.



Internally, "Tracking with buffering" is started (see command: *sNf*). Therefore, the latest measurement can also be read out from the device with the command *sNq*.

	<b>Set Command</b>	<b>Get Command</b>
Command	<i>sNA+aaaaaaaa&lt;CrLf&gt;</i>	<i>sNA&lt;CrLf&gt;</i>
Return successful	<i>gNA?&lt;CrLf&gt;</i>	<i>gNA+aaaaaaaa&lt;CrLf&gt;</i>
Return error	<i>gN@Ezzz&lt;CrLf&gt;</i>	<i>gN@Ezzz&lt;CrLf&gt;</i>
Parameters	<i>N</i> Device ID <i>aaaaaaaa</i> Sampling time in 1 ms (Range: 0...86'400'000 ms, 0 → max possible rate) <i>zzz</i> Error code	

### 8.3.15 Set configuration parameters to factory default (*sNd*)

This command restores all configuration parameters to their factory default values. The parameters are written to the flash memory and therefore permanently saved.



This will also reset the communication settings to the factory default.

	<b>Command</b>	
Command	<i>sNd&lt;CrLf&gt;</i>	
Return successful	<i>gN?&lt;CrLf&gt;</i>	
Return error	<i>gN@Ezzz&lt;CrLf&gt;</i>	
Parameters	<i>N</i> Device ID <i>zzz</i> Error code	

### 8.3.16 Save configuration parameters (*sNs*)

This command saves all configuration parameters, which are set by the configuration commands above. The parameters are written to the flash memory.

	<b>Command</b>	
Command	<i>sNs&lt;CrLf&gt;</i>	
Return successful	<i>gNs?&lt;CrLf&gt;</i>	
Return error	<i>gN@Ezzz&lt;CrLf&gt;</i>	
Parameters	<i>N</i> Device ID <i>zzz</i> Error code	

## 8.4 Extended configuration commands

### 8.4.1 Set/Get user output format (sNuo)

This command allows the configuration of a user specific output format. The configuration only affects the selected serial interface RS-232, RS-422/485 and USB. For more details about the data output of the D-Series sensor, see 6.4 Data output.

The user output format can be configured to fit the requirement of an external ASCII display. A parameter for the output format between 100 and 199 defines the format for an external display (User gain / offset are used too). The parameter (b) defines the field length of the ASCII display (including decimal point). The decimal point will be inserted at the position (counted from the right) defined by the parameter (a). The distance on the display will be right aligned. This format configuration is not applicable for RS-485.

It is also possible to use the default output format / protocol (Factory default) with a configured user gain and offset. The command parameter value of 200 sets this default format with activated user gain and offset (8.4.2 Set/Get user distance offset (sNuof) and 8.4.3 Set/Get user distance gain (sNuga).

With some extended distance output format configurations (sNuo+300, sNuo+301), it's possible to add signal, temperature and speed information to the default distance output format. The configured user gain and offset are considered for these output formats too.

	<b>Set command</b>	<b>Get command</b>
Command	sNuo+aaaaaaa<CrLf>	sNuo<CrLf>
Return successful	gNuo?<CrLf>	gNuo+aaaaaaa<CrLf>
Return error	gN@Ezzz<CrLf>	gN@Ezzz<CrLf>
Parameters	<p><i>N</i> Device ID</p> <p><i>aaaaaaa</i> Output format            0 → Default format (Factory setting), e.g. "g0g+00001234\r\n"            1ab → Display output format (For external display), e.g. "1.234\r\n"            a → Number of digits after decimal point            b → Field with (sign included) must be greater than 0            Conditions: a≤b, if a=b, no decimal point is output.            200 → Default format with user offset / gain active, e.g. "g0g-00000234\r\n"            Distance output = (Distance + Offset) * Gain            300 → Extended distance format and user offset / gain active.            Format: Distance [0.1 mm] + Signal [1] + Temperature [0.1°C]            e.g. "g0g+00000234+008384+254\r\n"            301 → Extended distance format with additional speed data and user offset / gain active            Format: Distance [0.1 mm] + Signal [1] + Temperature [0.1°C] + Speed [mm/s]            e.g. "g0g+00000234+008384+254+000500\r\n"            Remark: Speed value of +999999 indicates invalid speed data (only in Moving Target with distance jumps).</p> <p><i>zzz</i> Error code</p>	

### 8.4.2 Set/Get user distance offset (sNuof)

The user can set an individual user offset to create a user defined distance output value. This configuration takes effect in all distance measurement commands but only if the corresponding user output format is activated (see 8.4.1 Set/Get user output format (sNuo) for more details). The calculation of the user offset is described in 6.4.2 User gain / offset.



The user distance offset is only considered for the corresponding user output format and on the selected serial interface RS-232, RS422/485 and USB.

	<b>Set command</b>	<b>Get command</b>
Command	sNuof+aaaaaaa<CrLf>	sNuof<CrLf>
Return successful	gNuof?<CrLf>	gNuof+aaaaaaa<CrLf>
Return error	gN@Ezzz<CrLf>	gN@Ezzz<CrLf>
Parameters	<p><i>N</i> Device ID</p> <p><i>aaaaaaa</i> Offset in 0.1 mm (+/- offset possible)</p> <p><i>zzz</i> Error code</p>	



### 8.4.3 Set/Get user distance gain (sNuga)

The user can set an individual user gain to create a user defined distance output value. This configuration takes effect in all distance measurement commands but only if the corresponding user output format is activated (see 8.4.1 Set/Get user output format (sNuo) for more details). The calculation of the user gain is described in 6.4.2 User gain / offset.



The user distance offset is only considered for the corresponding user output format and on the selected serial interface RS-232, RS422/485 and USB.

	<b>Set command</b>	<b>Get command</b>
Command	sNuga+aaaaaaaa+bbbbbbbb<CrLf>	sNuga<CrLf>
Return successful	gNuga?<CrLf>	gNuga+aaaaaaaa+bbbbbbbb<CrLf>
Return error	gN@Ezzz<CrLf>	gN@Ezzz<CrLf>
Parameters	<i>N</i> Device ID <i>aaaaaaaa</i> GainNum → Numerator of gain calculation <i>bbbbbbbb</i> GainDen → Denominator of gain calculation ( <b>Attention: GainDen ≠ 0, must not be zero</b> ) <i>zzz</i> Error code	

### 8.4.4 Set/Get user mode (sNum)

This command allows the configuration of special user modes.

	<b>Set command</b>	<b>Get command</b>
Command	sNum+a<CrLf>	sNum<CrLf>
Return successful	gNum?<CrLf>	gNum+aaaaaaaa<CrLf>
Return error	gN@Ezzz<CrLf>	gN@Ezzz<CrLf>
Parameters	<i>N</i> Device ID <i>a</i> User mode number: 0 → Default mode, no user mode active 2 → Activate user mode for auto start with serial output enable (RS-232, RS-422/485, USB) 5 → Activate user mode for linear signal output (e.g. used for signal monitoring function) Other → Not used <i>zzz</i> Error code	

### 8.4.5 Set/Get additional measurement filter configuration (sNafi)

This command allows additional measurement filter / feature configurations. For more details about the available configurations see the corresponding chapter 6.4.5.

	<b>Set command</b>	<b>Get command</b>
Command	sNafi+a+bbbbbbbb<CrLf>	sNafi+a<CrLf>
Return successful	gNafi+a?<CrLf>	gNafi+a+bbbbbbbb<CrLf>
Return error	gN@Ezzz<CrLf>	gN@Ezzz<CrLf>
Parameters	<i>N</i> Device ID <i>a</i> Additional filter / feature number: 1 → Max. allowed distance change / jump configuration 2 → Calming filter configuration for distance measurements in Moving Target 3 → Max. allowed signal change (signal monitoring) configuration Other → Not used <i>bbbbbbbb</i> If a = 1 → Max. allowed distance change / jump in 0.1 mm (0 → Filter / Feature disabled) If a = 2 → Calming filter length 1...400 (0 → Filter disabled) If a = 3 → Max. allowed signal change / jump in % (0 → Filter / Feature disabled) <i>zzz</i> Error code	

### 8.4.6 Set/Get additional digital output configuration (sNado)

This command allows additional digital output configuration possibilities (data source, function and pulse width) for the digital output 1 and 2. For every output the data source, switching function and pulse width can be configured. For details about the configuration possibilities and its functionality see the corresponding chapter 6.5.

	<b>Set command</b>	<b>Get command</b>
Command	sNado+a+bbb+ccc+ddddddd<CrLf>	sNado+a<CrLf>
Return successful	gNado+a?<CrLf>	gNado+a+bbb+ccc+ddddddd<CrLf>
Return error	gN@Ezzz<CrLf>	gN@Ezzz<CrLf>
Parameters	<i>N</i> Device ID <i>a</i> Digital output number (1 or 2) <i>bbb</i> Data source used for the corresponding digital output: 0 → Distance. Digital output levels (ON, OFF) and pulse width in [0.1 mm] 1 → Speed. Digital output levels (ON, OFF) and pulse width in [mm/s] 2 → Signal. Digital output levels (ON, OFF) and pulse width in [1] 3 → Temperature: Digital output levels (ON, OFF) and pulse width in [0.1°C] <i>ccc</i> Switching function of the corresponding digital output: 0 → Hysteresis. Digital output levels (ON, OFF) used. 1 → Pulse. Digital output levels (ON, OFF) and pulse width used. <i>ddddddd</i> Pulse width in [0.1 mm], [mm/s], [1] or [0.1°C] (only used for pulse switching function) <i>zzz</i> Error code	

## 8.5 Information commands

### 8.5.1 Get software version (sNsv)

Reads the software version of the D-Series device.

	<b>Command</b>	
Command	sNsv<CrLf>	
Return successful	gNsv+aaaabbbb<CrLf>	
Return error	gN@Ezzz<CrLf>	
Parameters	<i>N</i> Device ID <i>aaaa</i> Internal measuring module software version <i>bbbb</i> Interface software version <i>zzz</i> Error code	

### 8.5.2 Get serial number (sNsn)

Reads the serial number of the D-Series device.

	<b>Command</b>	
Command	sNsn<CrLf>	
Return successful	gNsn+aaaaaaaa<CrLf>	
Return error	gN@Ezzz<CrLf>	
Parameters	<i>N</i> Device ID <i>aaaaaaaa</i> Serial number of the device <i>zzz</i> Error code	

### 8.5.3 Get device type (sNdt, dt)

Reads the device type of D-Series device.



Never use dt command if more than one device is connected to the serial interfaces.



<b>Command</b>	
Command	sNdt<CrLf> dt<CrLf>
Return successful	gNdt+0xyy<CrLf>
Return error	gN@Ezzz<CrLf>
Parameters	<i>N</i> Device ID <i>x</i> Device series number <i>yy</i> Device number Output for <i>0xyy</i> 0401 → D-Series laser sensor <i>zzz</i> Error code

### 8.5.4 Get device generation and type (dg)

Reads the device generation & type of the D-Series devices. The answer includes the device type, device generation and the active communication setting. Works only for newer sensor generations (starting from device generation C).



Never use this command if more than one device is connected to the serial interfaces.

<b>Command</b>	
Command	dg<CrLf>
Return successful	gNdg+aaa+bc<CrLf>
Return error	gN@Ezzz<CrLf>
Parameters	<i>N</i> Device ID <i>aaa</i> Bit coded number to identify the device: 0x54 (84) → D-Series sensor <i>b</i> Internal information <i>c</i> Communication settings in hex value (see command sNbE) <i>zzz</i> Error code

## 8.6 Error codes

The following table lists the most important error codes of the D-Series devices. For not listed error codes, please contact Dimetix.

No. <sup>1)</sup>	Format	Description	Troubleshooting
0		No error	No troubleshooting
200		Boot-up event of sensor	Used for error stack to see boot-up of the sensor
203	@E203	Wrong command, parameter or syntax	Check command, parameter and communication settings (Baud rate, stop bits, parity and termination).
210	@E210	Sensor not in tracking mode	Start tracking measurement first.
211	@E211	Tracking measurement time too short	Tracking measurement time of the device is too short for the measurement conditions. Increase measurement time or improve measurement conditions.
212	@E212	Command cannot be executed, while tracking measurement is active	Measurement has to be stopped with Stop / Clear command sNc before execute the new command.
220	@E220	Error in the serial communication	Check communication settings (Baud rate, stop bits, parity and termination).
230	@E230	Distance value overflow caused by wrong user configuration.	Check user offset / gain configuration.
233	@E233	Number cannot be displayed	Check output format
234	@E234	Distance not in measurement range	Check measurement setup and distance to the measuring surface / target.



No. <sup>1)</sup>	Format	Description	Troubleshooting
236	@E236	Conflict in digital input / output DI1/DO1 configuration	Check digital input / output DI1/DO1 configuration. Only input or output possible, otherwise input / output conflict.
252	@E252	Temperature too high	Reduce ambient temperature. Contact Dimetix if the error occurs at room temperature.
253	@E253	Temperature too low	Increase ambient temperature. For device with heater functionality, wait until heater increased temperature. Contact Dimetix if the error occurs at room temperature.
255	@E255	Received signal too low or distance not in range	Check measurement setup and use a higher reflective measuring surface. Contact Dimetix if the error persist after checking the measurement setup.
256	@E256	Received signal too high	Check measurement setup and use a lower reflective measuring surface. Prevent measuring high reflective / high glossy surfaces, for details see chapter 7.4 Prevention of erroneous measurements. Contact Dimetix if the error persist after checking the measurement setup.
257	@E257	Signal to Noise (SNR) too low (Background light too strong)	Increase signal from measuring target (check measuring target) and / or reduce background lights / noise (sunlight or other strong light source).
258	@E258	Power supply voltage is too high	Check the supply voltage against the device specification.
259	@E259	Power supply voltage is too low	Check the supply voltage against the device specification.
260	@E260	Signal too unstable for a distance measurement	Check the measurement setup and use stable measuring surface.
261	@E261	Distance change/jump higher than set limit	Check the application for not allowed distance jumps or adapt the configured limit. Restart measurement to clear the error condition.
262	@E262	Signal change/jump higher than set limit	Check the application for not allowed signal changes or adapt the configured limit. Restart measurement to clear the error condition.
263	@E263	Measurement not on Dimetix reflective surface	Check the measurement surface or the sensor alignment. Measurements on Dimetix orange reflective surface only is active.
284	@E284	Signal disturbance in the laser output	Check the small laser output glass for pollution. Clean the optical part carefully with a clean soft glasses cleaning cloth or cotton buds and avoid scratching.
290	@E290	Signal disturbance in the sensor optic e.g. laser output or receiver lens	Check the small laser output glass and the receiver lens for pollution. Clean the optical parts carefully with a clean soft glasses cleaning cloth and avoid scratching. Contact Dimetix if the error persist after checking the measurement setup.
400	@E400	Firmware download for Industrial Ethernet module not possible, module is busy	Check connection and power of the D-Series device. Proceed a power cycle and restart firmware download.
401	@E401	Firmware download for Industrial Ethernet module not possible, no module connected	Connect the Industrial Ethernet to the D-Series device before starting firmware download.
402	@E402	Firmware download for measurement module not possible	Check connection and power of the D-Series device. Proceed a power cycle and restart firmware download.
501	@E501	Industrial Ethernet distance out of range	Check measurement setup and distance to the measuring surface / target. Distance value must not be out of range 0...500 m.
502	@E502	Industrial Ethernet speed integer out of range	Speed data must not exceed $\pm 20$ m/s. Check for plausibility and measurement setup.
503	@E503	Industrial Ethernet distance integer or float out of range	Check distance unit settings and distance value according range of integer value. Distance value must not exceed 500 m.
Not listed		Please contact Dimetix	

<sup>1)</sup> To calculate the error code out of the SSI error data (see 8.3.10 Set/Get configuration of RS-422/485 and SSI (sNSSI)), do the calculation as follows:  
 Error code = SSI error data +200.

Before contacting Dimetix, please prepare information about the following subjects. This will help to find out the cause of a failure / error.

- Device type and serial number
- Error code / codes and status LED's
- Short description of measuring setup (Used interface, configuration, measuring target, measurement conditions, etc.)
- Short description of the device behavior before, during and after error



## 9 Frequently asked questions (FAQ's)

For the up to date library of frequently asked questions see the knowledge base on the Dimetix website <https://dimetix.com/knowledge-base/>.

## 10 Glossary

ASCII	American Standard Code for Information Interchange (ASCII)
ESD	Electrostatic Discharge
EMC	Electromagnetic Compatibility
Industrial Ethernet	Industrial Ethernet interfaces e.g. PROFINET, EtherCAT, EtherNet/IP (Real-Time Ethernet interfaces)
PLC	Programmable Logic Controller (e.g. Siemens S7)
SSI	Serial Synchronous Interface (SSI)

## 11 Revision history

The release versions and the changes of this Technical Reference Manual are listed below.

Date	Revision	Changes
22.08.2017	V1.00	First release of the Technical Reference Manual.
26.09.2017	V1.01	Some additions in the descriptions of the electrical interfaces according EMC testings and requirements.
06.02.2018	V1.03	Some additional descriptions of user output protocol.
16.05.2018	V1.04	Some additional descriptions for Industrial Ethernet interface and data output.
02.07.2018	V1.05	Corrections in the digital input specifications. Description for heating functionality added. Support of sensor ID range 0...99 in the chapter of RS-422/485 interface. Some quality optimizations in charts and diagrams.
04.10.2018	V1.06	Revised figure about output data flow and configuration possibilities in chapter 6.4 Data output. Added chapter 6.4.4 Moving Target filter with description of filter characteristic and output rate. Added calculation guidelines in chapter 5.6 Analog output for the use of high load resistances (up to 500 Ω).
24.09.2019	V1.07	Small correction for the output filter drawings in chapter 6.4.3. Added new sensor types DEN-10-500, DEH-30-500 and DBN-50-050 in chapter 3.1 and 4.1. Added new command for configuration of user mode and overworked the auto start configuration process. See chapter 6.2, 6.2.2 and 8.4.4 for details. Completed the measurement characteristic and Corrections in conjunction with the device ID. Device ID configuration range is 0...99 and for RS-422/485 up to 100 devices can be connected.
22.10.2019	V1.08	Added new configuration possibilities for the user output format in chapter 6.4.1 and 8.4.1.
02.03.2020	V1.09	Moved chapter 2 Safety instructions (new chapter 2, old chapter 7) Moved chapter 2.7 Laser specification (new chapter 2.7, old chapter 7.10) New chapters 1 Document scope and 2.1 Explanation of symbols. New chapter 2.2 Permitted use and 2.3 Prohibited use/Limits to use replace old chapter 7.1 Use of the instrument and 7.2 Limits to use. Revised all Warning, Caution and Notice messages in the document: Symbols and text changed. Added reference to Laser specification in the Specifications table chapter 4.1 (Row: Light source).
16.03.2020	V1.10	New chapter 6.4.5 Additional filter functionality for additional configuration possibilities.
03.02.2021	V1.11	New error code @E261, @E284 and @E290 with error description in chapter 8.6. Extended troubleshooting description for error code @E256 in chapter 8.6. Added relative humidity (operation / storage) in the specification table. Revised chapter 7.2.2 Mounting of the device. Important notes for outdoor applications to protect the sensor. Added target torque value for the screws of the exchangeable cover in chapter 7.2.1 Connection of the device. New command for digital output pulse configuration in chapter 8.4.6. New get functionality for the user mode configuration command in chapter 8.4.4. Added target torque for Philips Slotted Combo screws in chapter 3.2. Added connection overview of the crew terminal block and plug in chapter 5. New digital output description in chapter 6.5 Digital output.
03.01.2022	V1.12	Error calculation formula of analog output corrected in chapter 5.6.1 Specifications. Added max. target speed for Moving Target measurement characteristic in chapter 6.3 Measuring characteristic. Added configuration value range for analog output value in error case in chapter 8.3.4. Improved description of the SSI configuration command in chapter 8.3.10. Improved and supplemented description of the extended distance format with additional speed data in chapter 8.4.1 Set/Get user output format (sNuo). New information about invalid speed data in Moving Target measurement characteristics. Added SSI 25 data bit configuration option in chapter 8.3.10.



		<p>New additional filter configuration (sNafi+3) in chapter 6.4.5 Additional filter functionality and 8.4.5 Set/Get additional measurement filter configuration (sNafi).</p> <p>New user mode 5 in chapter 8.4.4 Set/Get user mode (sNum).</p>
24.02.2023	V1.13	<p>Added note "user display output format not applicable for RS-485 interface" in chapter 6.4.1 User output format / protocol and 8.4.1 Set/Get user output format (sNuo).</p> <p>Added recommended contact size for the shield tab in chapter 3.2.</p> <p>Removed reference to PROFIBUS interface (external) in specification table in chapter 4.1.</p> <p>Added remarks that display output format is not applicable for RS-485 interface in chapter 6.4.1 and 8.4.1.</p> <p>Added Application Note references in the table in chapter 6.4.5.</p> <p>Added text in the command table in chapter 8.4.5 for better understanding.</p> <p>Added error code @E262 in chapter 8.6.</p> <p>Added command example with device ID in chapter 8.1.4.</p> <p>Changed max. measuring and output rate from 50 Hz to 100 Hz and typical time for a measurement from 0.02 s to 0.01 s for sensor types DEN, DEH, DAN and DAE in the specification table in chapter 4.1.</p>
21.03.2023	V1.14	<p>Added footnote no. 11 in the specification table in chapter 4.1.</p> <p>Added footnote no. 6 in the measurement characteristic table in chapter 6.3.</p>
24.11.2023	V1.15	<p>Added bit rate (bps) for baud rate definition in the table in chapter 8.3.1.</p> <p>Added error codes @E501, 502 and 503 for Industrial Ethernet interface in chapter 8.6.</p> <p>Added note that the use of filters only makes sense for continuous distance measurement in chapter 6.4.3.</p> <p>Clarification of typical laser diode center wavelength to 655 nm in the table in chapter 4.1.</p>
24.07.2025	V1.16	<p>Updated IEC standard and FDA laser notice 56 in chapter 2.6, 2.7 and 4.1. Updated laser label in chapter 2.11 and in important notice on final page.</p> <p>Corrections in footnote chapter 5.6.1, incorrect designation.</p> <p>Correction in command description in chapter 8.3.10.</p> <p>Added new error code @E263 in the error table in chapter 8.6.</p>



**Important Notice**

Dimetix reserves the right to make corrections, modifications, enhancements, improvements and other changes to its products, documentation and services at any time and to discontinue any product or service without notice. We try to give our best possible effort to provide you with perfect documents, but we can not guarantee for incorrect information. Customers should obtain the latest relevant information before placing orders and should verify that such information is up to date and complete. All products are sold subject to Dimetix terms and conditions of sale supplied at the time of order acknowledgment.



Wavelength: 620-690nm, Max Power < 1mW  
Complies with 21 CFR 1040.10 and 1040.11 except  
for conformance with IEC 60825-1 Ed. 3., as  
described in Laser Notice No.56, dated May 8, 2019

© Copyright by Dimetix

Dimetix AG  
Degersheimerstr. 14  
CH-9100 Herisau  
Switzerland

Tel. +41 71 353 00 00  
Fax +41 71 353 00 01  
info@dimetix.com  
[www.dimetix.com](http://www.dimetix.com)

